



**NOVO series**  
workstations

# Contents.

## **NOVO Series Workstations.**

Specifications	p.3 - p.6
NOVO Frame (Tech) configurations	p.7 - p.11
NOVO a-Frame (Tech) configurations	p.12 - p.16
NOVO Max configurations	p.17 - p.19
Options	p.20 - p.28

## **Finishes.**

Boards - Group 1	p.29 - p.31
Powder Coat Range	p.32
Screen Fabric - Suzette	p.33 - p.34
Screen Fabric - Trilogy 1	p.35 - p.36
Ecoustic	p.37

## **Watts Commercial Furniture Policies.**

Environmental Policy	p.38
Quality Policy	p.39

# NOVO series

workstations



NOVO MAX workstations

**AFFORDABLE**

## **MULTI SOLUTION**

**WORKSTATIONS**

*The NOVO series provide wide range options to individual, shared and collaborative. It gives end-user different levels of flexibility to suit the every-changing and growing office.*

### GENERAL SPECIFICATIONS

	Standard length	Standard depth	Height range	Leg styles	Standard corner desk size	Range		
						rectangular desk	90° desk	120° desk
NOVO Frame	1200 / 1500 / 1800 / 2100 mm	600 / 750 / 900 mm	Fixed 720mm	Straight	Range (1pc) 1500 x 1500 - 1800 x 2100 mm	Yes	Yes	
NOVO Frame Tech			610 - 760mm (25mm increments)	Straight		Yes	Yes	
NOVO a-Frame			Fixed 720mm	Angled		Yes	Yes	
NOVO a-Frame Tech			610 - 760mm (25mm increments)	Angled		Yes	Yes	
NOVO Max			Fixed 720mm	Straight		Yes	Yes	Yes

**\* DEFAULT FRAME COLOUR: POWDER COAT RANGE - STANDARD**

**GENERAL FRAME STRUCTURE**

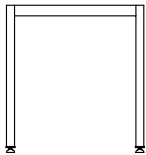

**NOVO Frame**  
fixed height

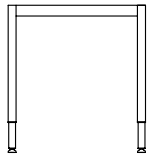

**NOVO Frame (Tech)**  
height adjustable

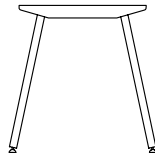

**NOVO a-Frame**  
fixed height



**NOVO a-Frame (Tech)**  
height adjustable



**NOVO Max**  
fixed height

**STANDARD WORKTOPS**

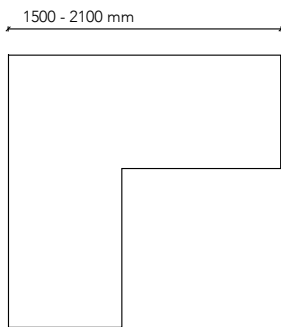

**Standard 90° corner desk (1 piece)**  
\*one side MAX. 1800mm

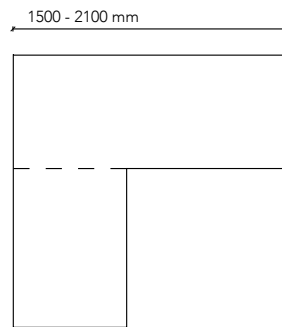

**Standard 90° corner desk (2 pieces)**

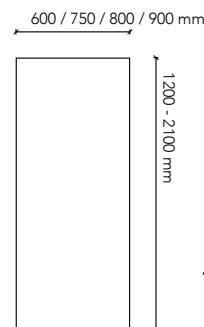

**Standard rectangular desk**

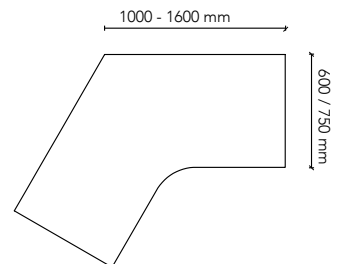

**Standard 120° desk**

**WORKTOPS CORNER FINISH OPTIONS**

Standard worktops can be specified 25mm(Standard) or 33mm thick with square or rounded corners (50mm / 100mm radius).

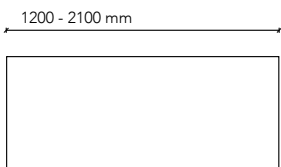

**Square corners**

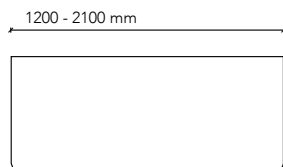

**50 mm radius to front corners**

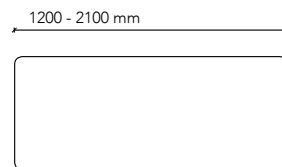

**50 mm radius to all corners**

**FOOT STYLES**

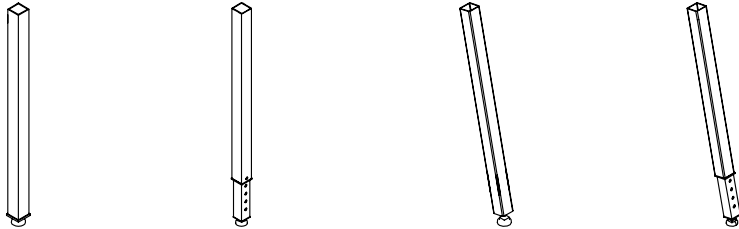

Fixed straight leg  
NOVO Frame  
NOVO Max

Adjustable straight leg  
NOVO Frame Tech

Fixed angled leg  
NOVO a-Frame

Adjustable angled leg  
NOVO a-Frame Tech

**EDGE OPTIONS**

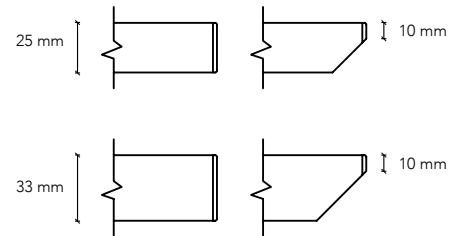

Standard

Sharknose

**EXCESS CABLES - CUTOUT**

Excess cables can be taken off the desk with a cutout, a cable port or a cable brush. Must be specified with the worksurface

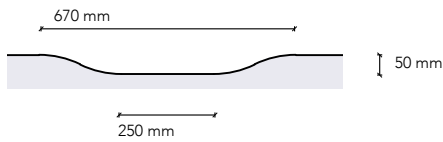

Large Scallop

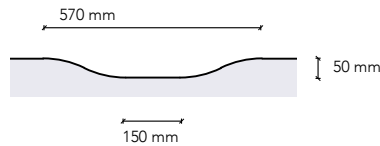

Small Scallop

**EXCESS CABLES - CABLE BRUSH / CABLE FLAPS**

Excess cables can be taken off the desk with a cutout, a cable port or a cable brush. Must be specified with the worksurface

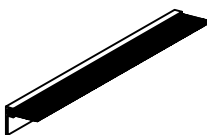

**Standard Cable Brush**

Must be specified with the worksurface

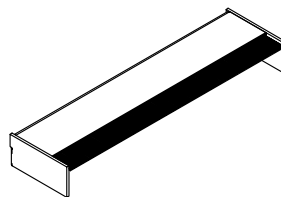

**Standard Cable Flaps**

Must be specified with the worksurface

**EXCESS CABLES - STANDARD 60MM CABLE PORT**

Excess cables can be taken off the desk with a cutout, a cable port or a cable brush. Must be specified with the worksurface

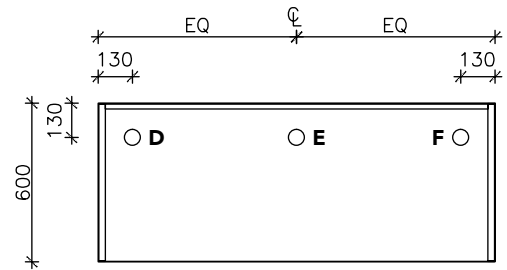
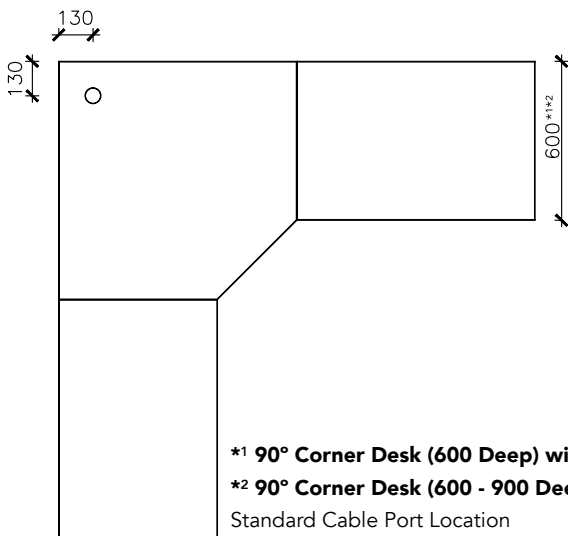
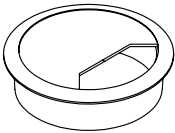

**Rectangular Desk (600 Deep)**  
 Without Modesty - Location D, E, F  
 With Modesty - Location D, E, F

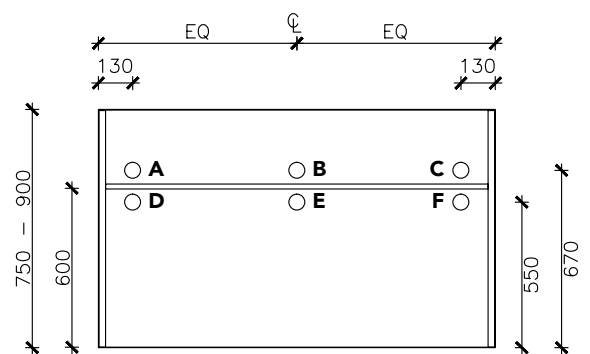
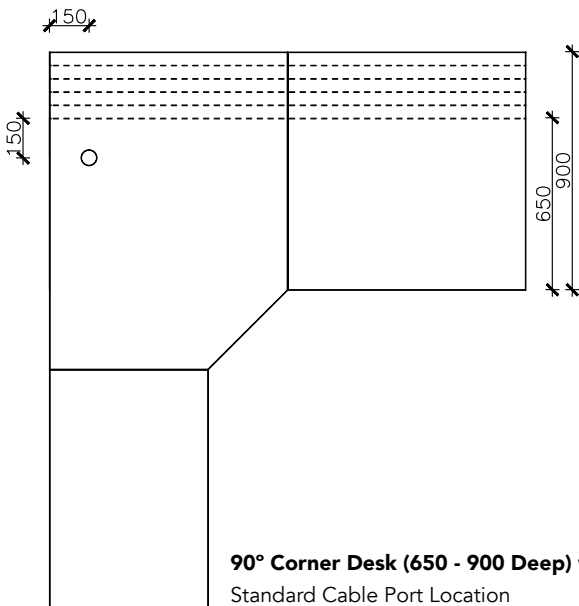

**Rectangular Desk (750 - 900 Deep)**  
 Without Modesty - Location A, B, C  
 With Modesty - Location D, E, F

## NOVO FRAME (Tech)

Height Adjustable  
610mm - 760 mm

## NOVO FRAME

Fixed Height  
720 mm

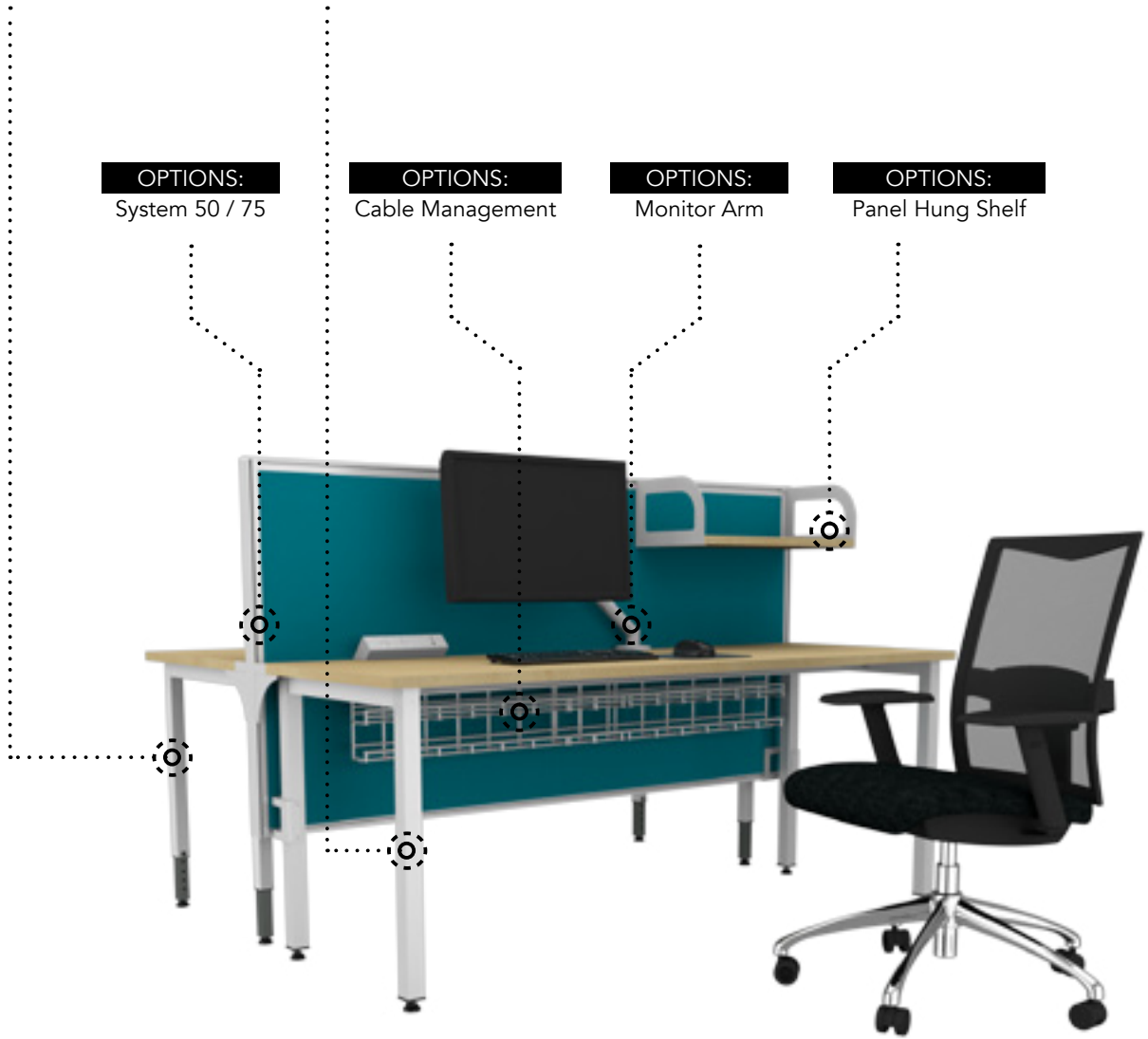

OPTIONS:  
System 50 / 75

OPTIONS:  
Cable Management

OPTIONS:  
Monitor Arm

OPTIONS:  
Panel Hung Shelf

**NOVO FRAME / Tech**  
workstations

# NOVO series.

desk layouts - novo frame / novo frame (tech)



## RECTANGULAR DESK

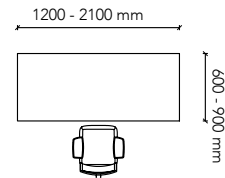
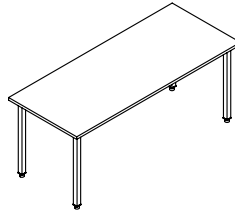

---

## RECTANGULAR DESK 2 WAY BACK TO BACK

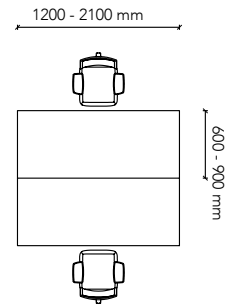
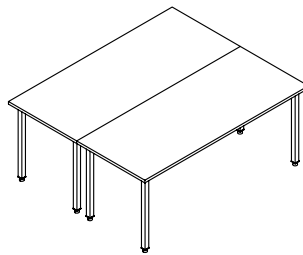

---

## RECTANGULAR DESK 2 WAY SIDE BY SIDE

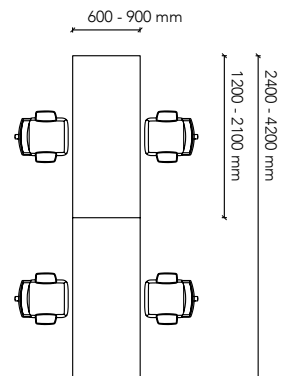
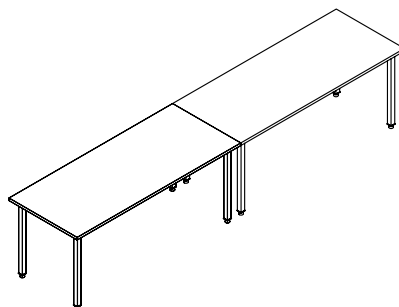



# NOVO series.

desk layouts - novo frame / novo frame (tech)



## RECTANGULAR DESK 4 WAY BACK TO BACK

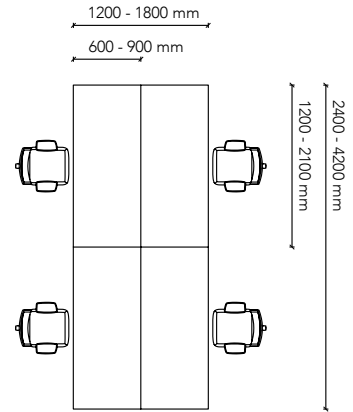
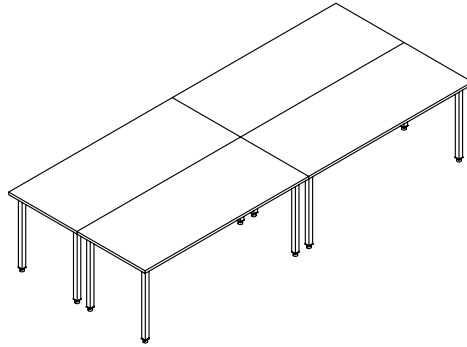

---

## 90° CORNER DESK

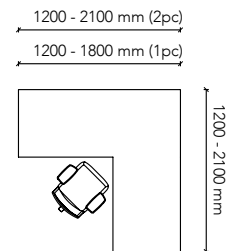
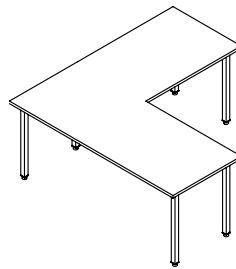

---

## 90° CORNER DESK 2-WAY T LAYOUT

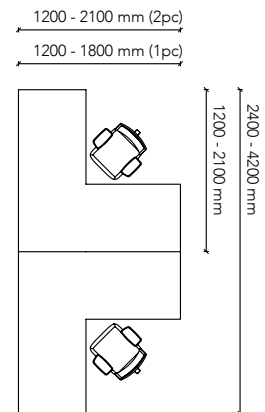
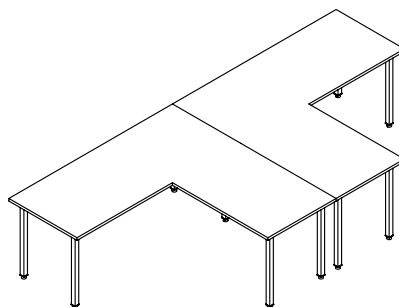

# NOVO series.

desk layouts - novo frame / novo frame (tech)



## 90° CORNER DESK 2-WAY U LAYOUT

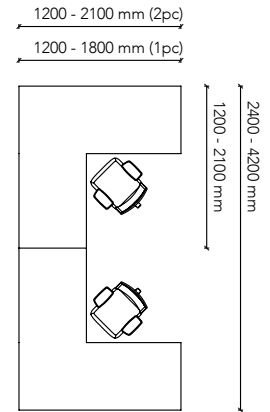
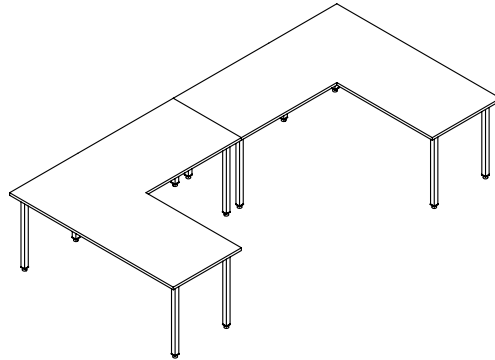

## 90° CORNER DESK 4-WAY H LAYOUT

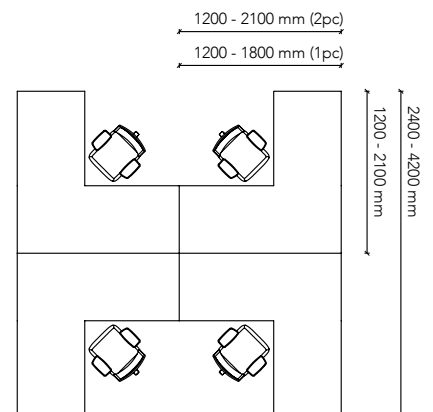
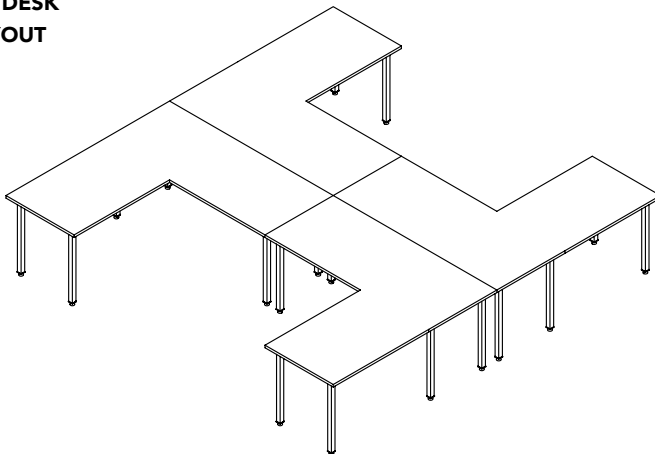

## 90° CORNER DESK 4-WAY U LAYOUT

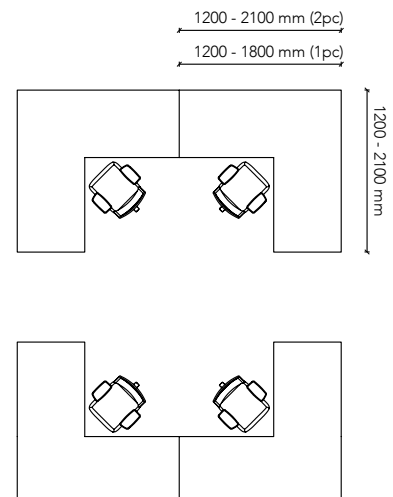
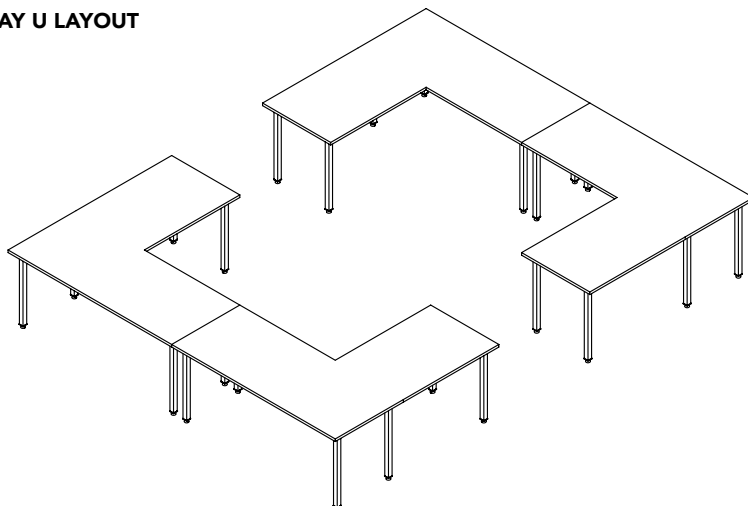

# NOVO series.

desk layouts - novo frame / novo frame (tech)



## 90° CORNER DESK 4-WAY CROSS LAYOUT

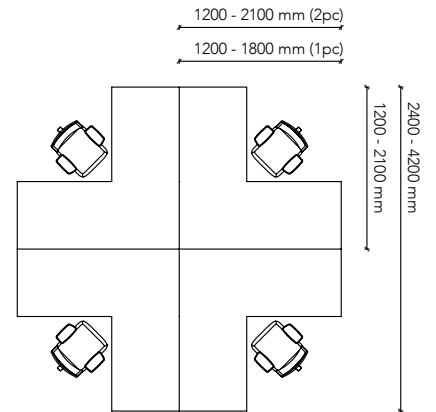
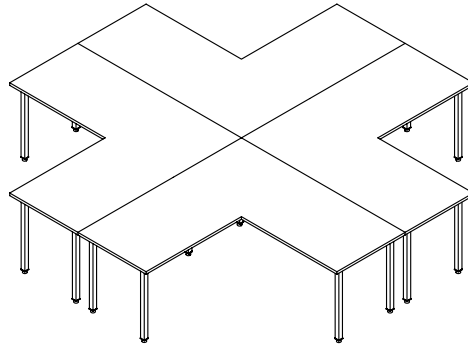

### NOVO FRAME

Client: University of Western Sydney  
Location: Kingswood

## NOVO a-FRAME (Tech)

Height Adjustable  
610mm - 760 mm

## NOVO a-FRAME

Fixed Height  
720 mm

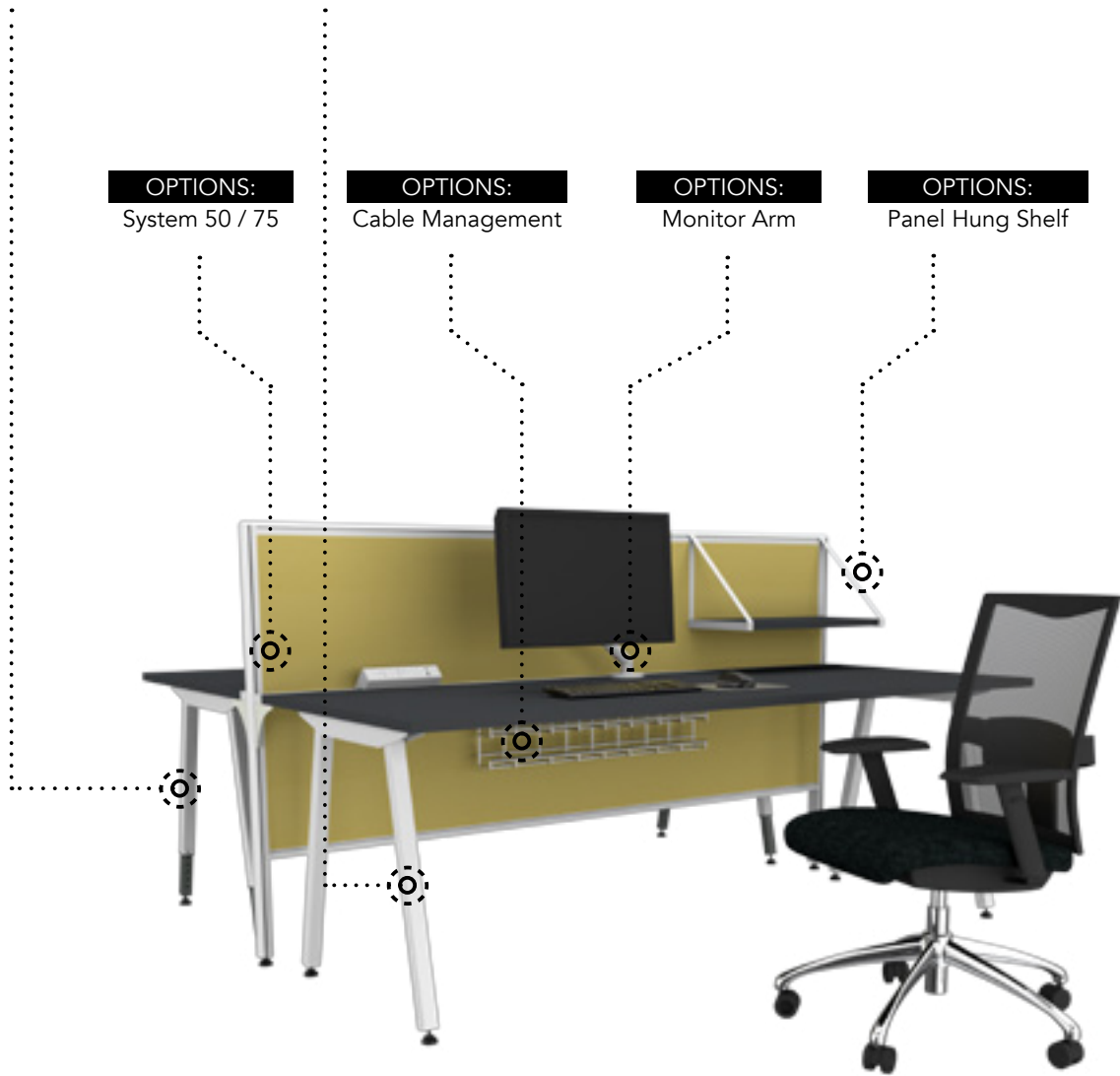

OPTIONS:  
System 50 / 75

OPTIONS:  
Cable Management

OPTIONS:  
Monitor Arm

OPTIONS:  
Panel Hung Shelf

**NOVO a-FRAME / Tech**  
workstations

# NOVO series.

desk layouts - novo a-frame / novo a-frame (tech)



## RECTANGULAR DESK

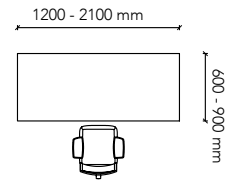
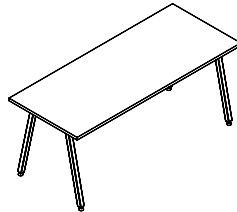

## RECTANGULAR DESK 2-WAY BACK TO BACK

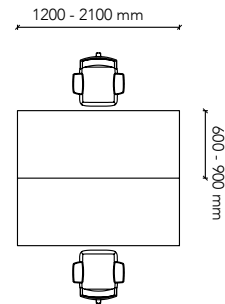
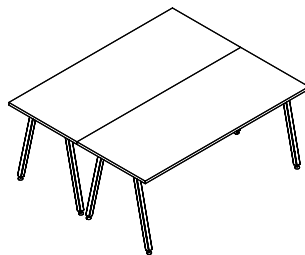

## RECTANGULAR DESK 2-WAY SIDE BY SIDE

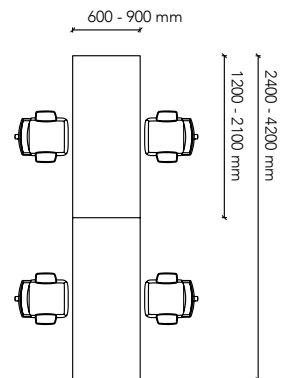
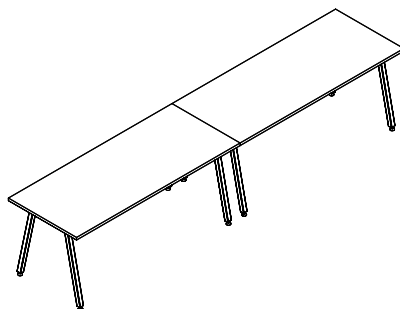

# NOVO series.

desk layouts - novo a-frame / novo a-frame (tech)



## RECTANGULAR DESK 4-WAY BACK TO BACK

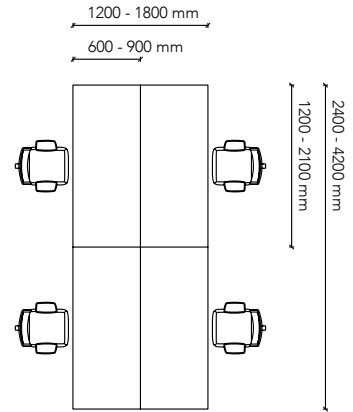
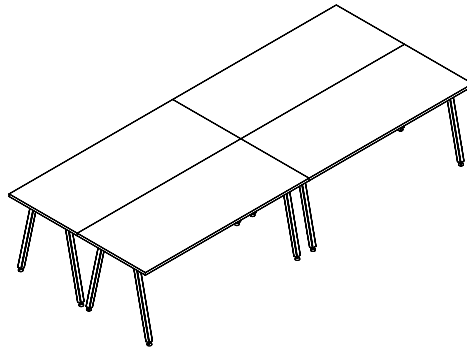

## 90° CORNER DESK

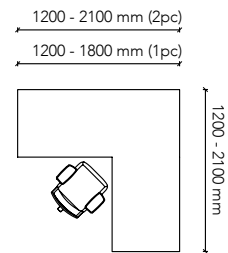
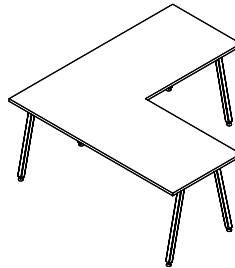

## 90° CORNER DESK 2-WAY T LAYOUT

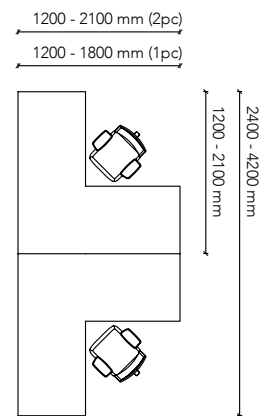
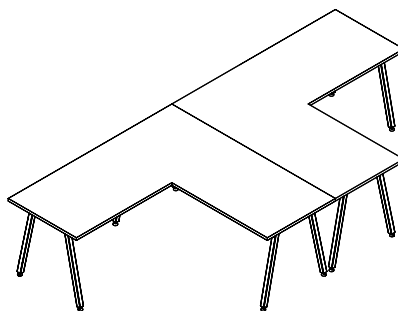

# NOVO series.

desk layouts - novo a-frame / novo a-frame (tech)



## 90° CORNER DESK 2-WAY U LAYOUT

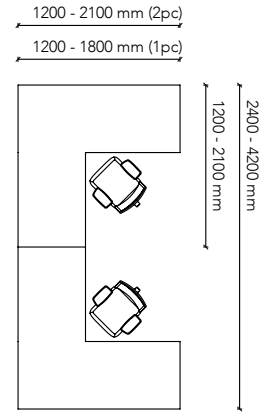
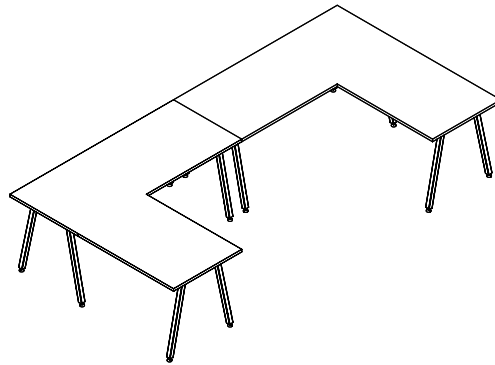

## 90° CORNER DESK 4-WAY H LAYOUT

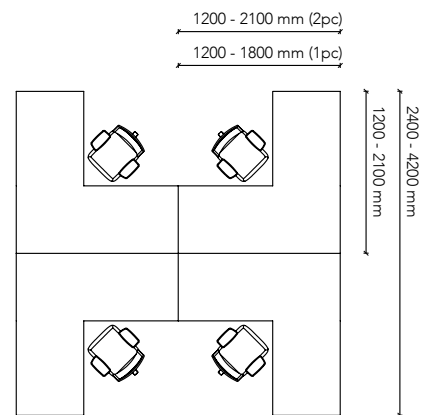
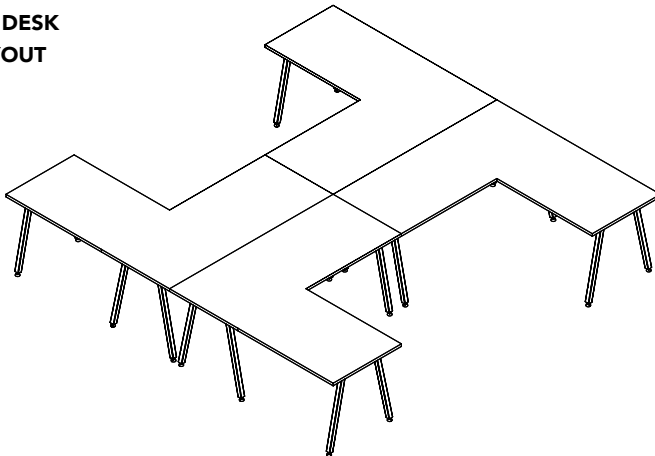

## 90° CORNER DESK 4-WAY U LAYOUT

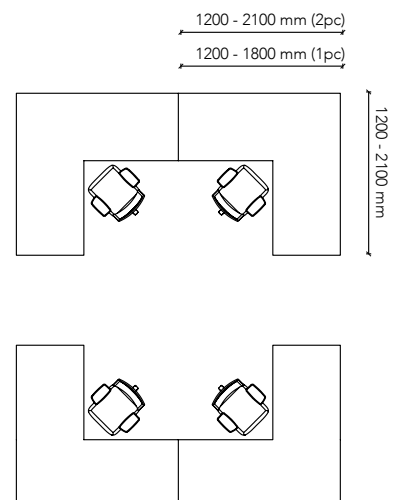
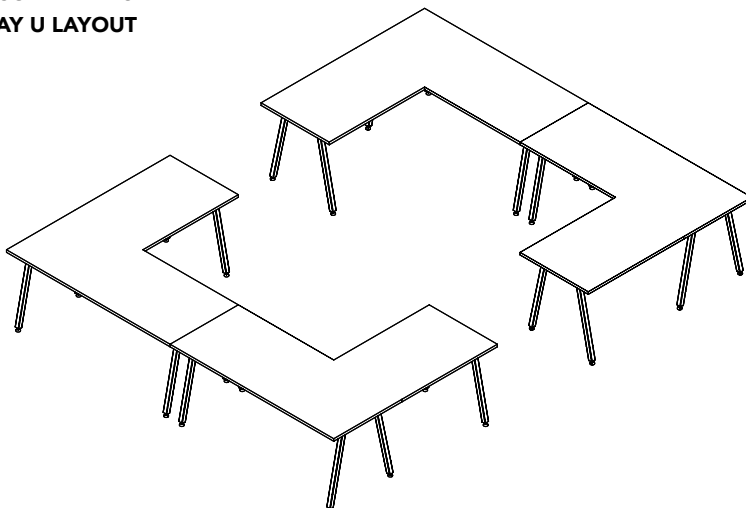

# NOVO series.

desk layouts - novo a-frame / novo a-frame (tech)



## 90° CORNER DESK 4-WAY CROSS LAYOUT

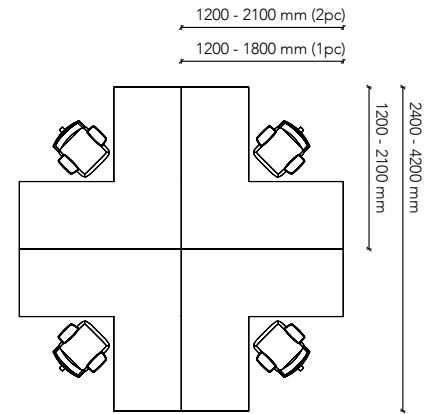
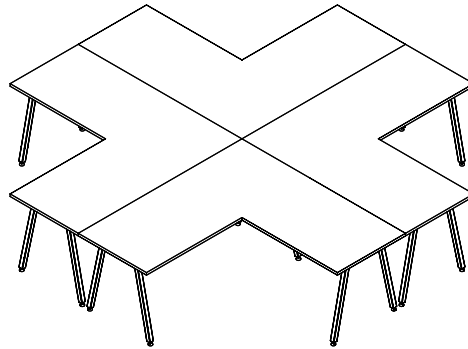

## NOVO a-FRAME (tech)

Client: Family & Community Services  
Location: Ashfield



## NOVO MAX

Fixed Height  
720 mm



**RECTANGULAR DESK  
2-WAY BACK TO BACK**

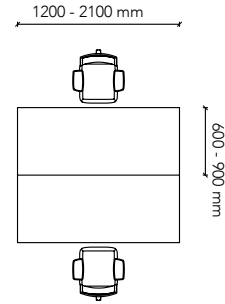
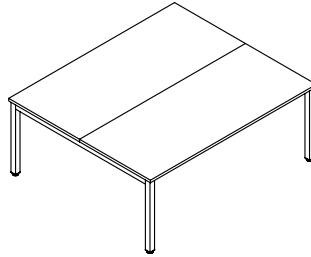

**RECTANGULAR DESK  
4-WAY BACK TO BACK**

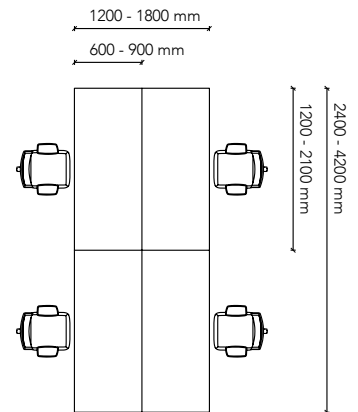
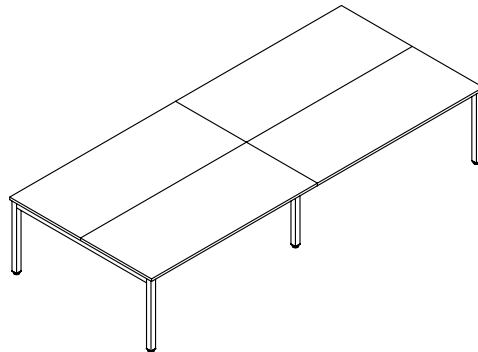

**90° CORNER DESK  
4-WAY CROSS LAYOUT**

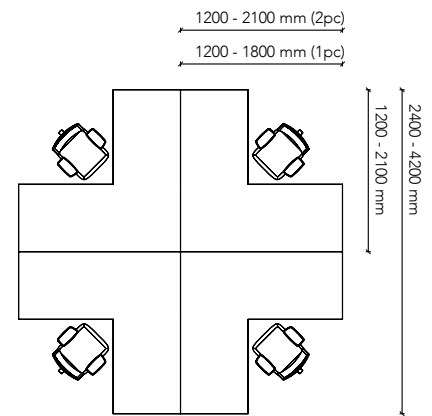
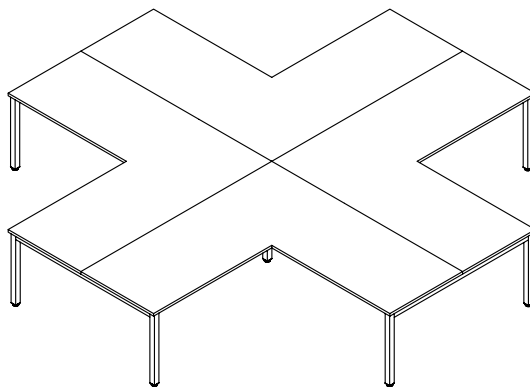

**120° 3-WAY WORKSTATION**

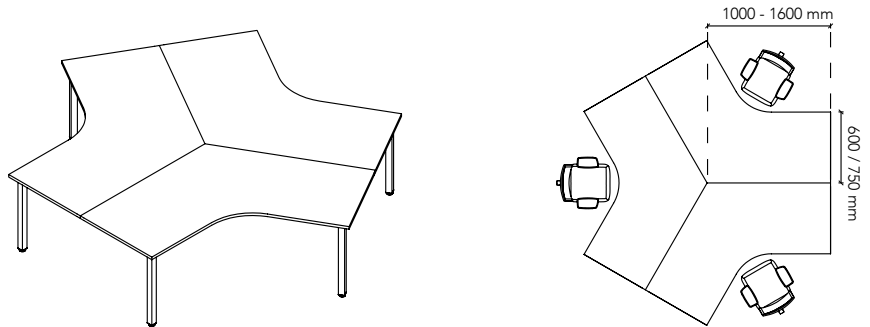

NOVO MAX - 120° WORKSTATIONS  
Waverley City Council

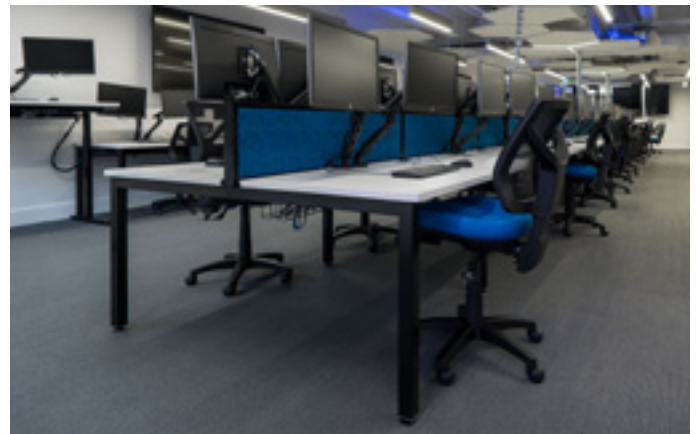

NOVO MAX WORKSTATIONS  
University of New South Wales Canberra



NOVO MAX 6-WAY WORKSTATIONS  
eHealth Parramatta



System 50 Screen  
50mm thick

**SYSTEM 50 CABLE MANAGEMENT**

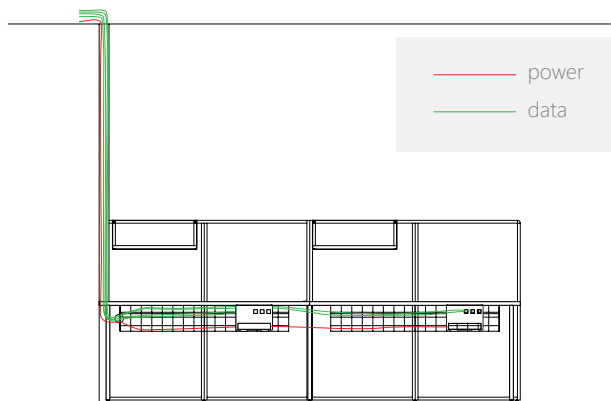

Power through Power blade, pole or umbilical to ceiling

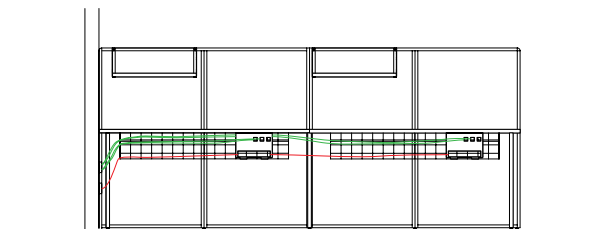

Power from wall mounted starter sockets to cable trays

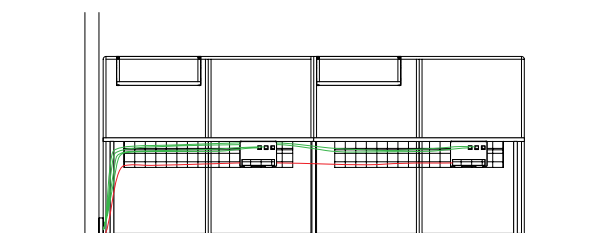

Power from duct mounted starter sockets to cable trays



System 75 Screen  
75mm thick

**SYSTEM 75 CABLE MANAGEMENT**

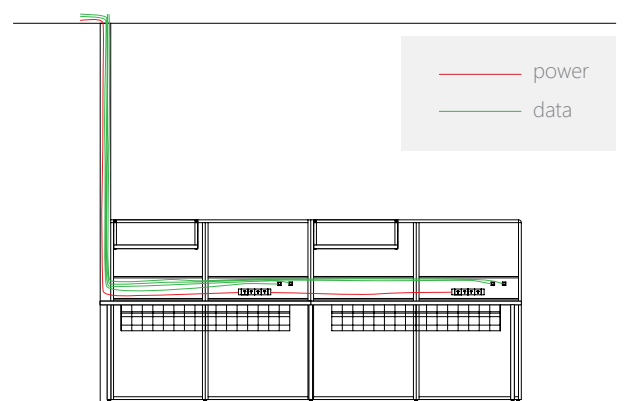

Power through Power blade, pole or umbilical to ceiling

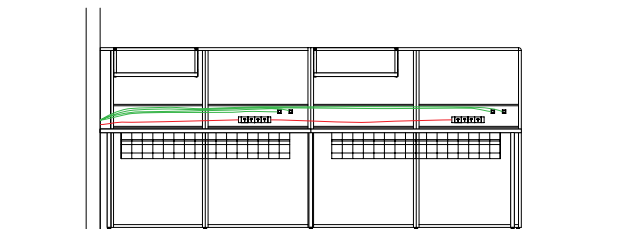

Power from wall through wall start into screen ducting

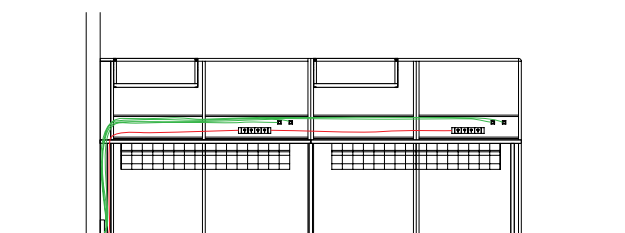

Power from ducted skirting through wall start into screen ducting

**SYSTEM 50/75 SCREEN WITH NOVO Frame, NOVO Frame (tech)**

Max. height FFL1500.

Min. height FFL900.

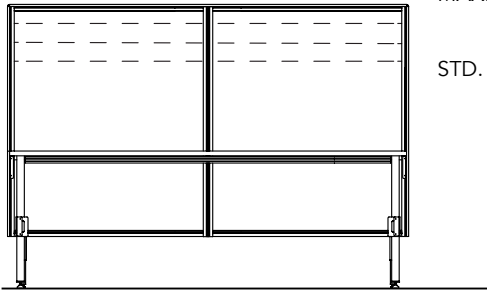

MAX. FFL 1500

STD. FFL 1200

FFL 0000

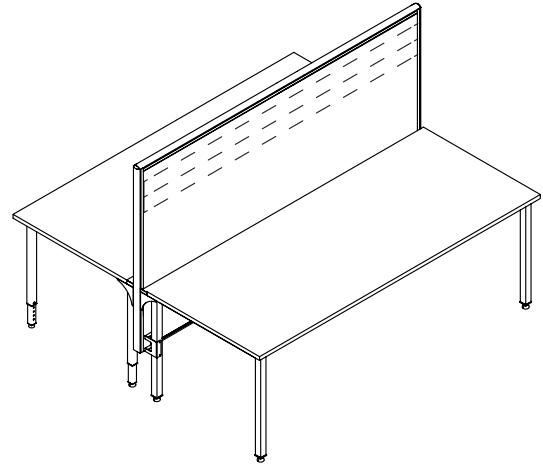

**SYSTEM 50/75 SCREEN WITH NOVO aFrame, NOVO aFrame (tech)**

Max. height FFL1500.

Min. height FFL900.

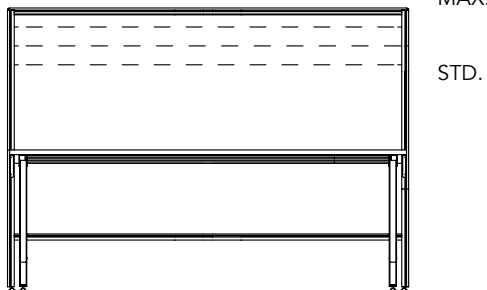

MAX. FFL 1500

STD. FFL 1200

FFL 0000

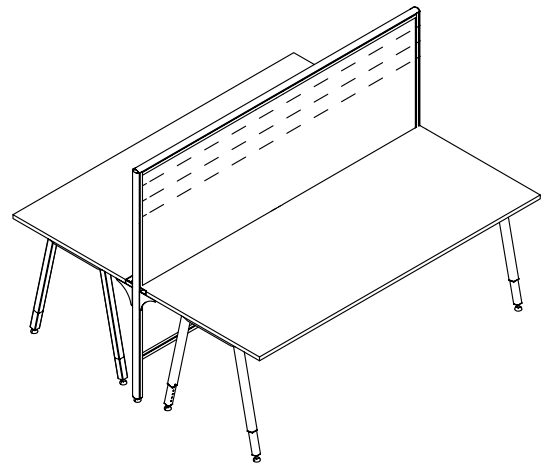

**SYSTEM 50/75 SCREEN WITH NOVO Max**

Max. height FFL1300.

Min. height FFL900.

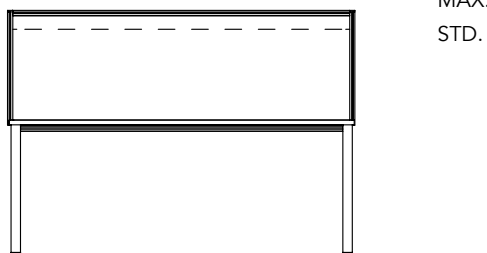

MAX. FFL 1300

STD. FFL 1200

FFL 0000

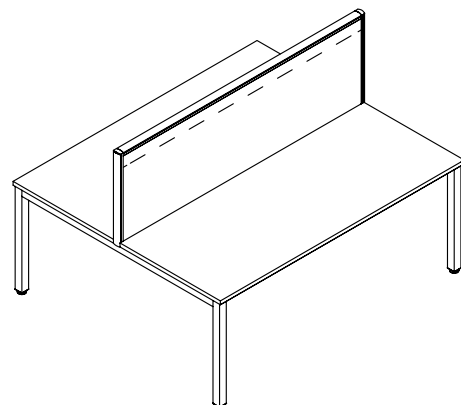

**PANEL HUNG SHELF (HORIZONTAL ADJUSTMENT)**

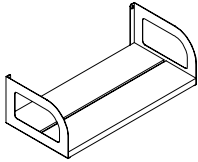

Panel Hung Shelf D-END  
(Aluminium)

Standard Size  
600W x 290D x 190H  
900W x 290D x 190H

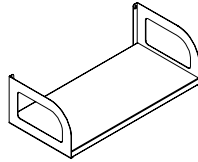

Panel Hung Shelf D-END  
(Melamine)

Standard Size  
600W x 290D x 190H  
900W x 290D x 190H

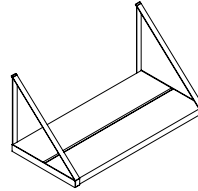

Panel Hung Shelf Wire-END  
(Aluminium)

Standard Size  
600W x 300D x 300H  
900W x 300D x 300H

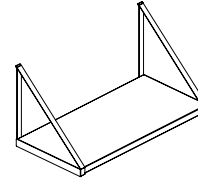

Panel Hung Shelf Wire-END  
(Melamine)

Standard Size  
600W x 300D x 300H  
900W x 300D x 300H

**PANEL HUNG SHELF (VERTICAL ADJUSTMENT)**

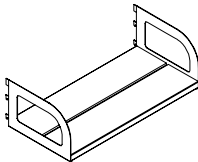

Panel Hung Shelf D-END  
(Aluminium)

Standard Size  
600W x 290D x 190H  
900W x 290D x 190H

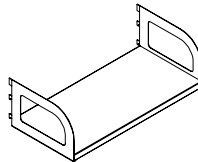

Panel Hung Shelf D-END  
(Melamine)

Standard Size  
600W x 290D x 190H  
900W x 290D x 190H

**SHELF DIVIDER**



Shelf Divider  
(Aluminium)

Standard Size  
270D x 175H

**WALL HUNG SHELF**

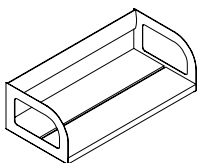

Panel Hung Shelf D-END  
(Aluminium)

Standard Size  
600W x 290D x 190H  
900W x 290D x 190H

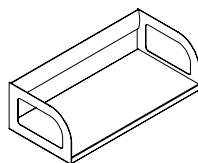

Panel Hung Shelf D-END  
(Melamine)

Standard Size  
600W x 290D x 190H  
900W x 290D x 190H

**CLAMP-ON ACCESSORIES**

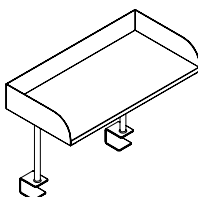

Clamp on Shelf

Standard Size  
600W x 300D x 100H  
325mm above benchtop

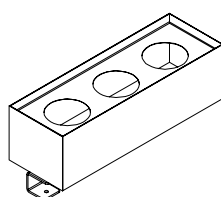

Clamp on Planter Box

Standard Size  
600W x 200D x 175H  
75mm above benchtop

**MOBILE STORAGE UNITS (MELAMINE)**

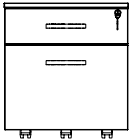

**MD5**  
470W x 570D x 510H

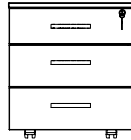

**MD6**  
470W x 570D x 510H

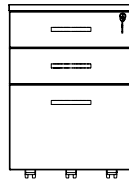

**MD7**  
470W x 570D x 650H

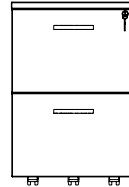

**MD8**  
470W x 570D x 690H

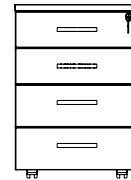

**MD9**  
470W x 570D x 650H

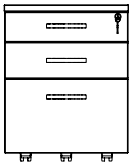

**MD10**  
470W x 570D x 600H

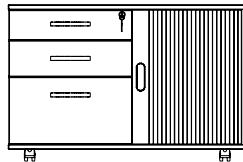

**MCT3**  
900W x 570D x 600H

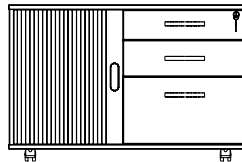

**MCT4**  
900W x 570D x 600H

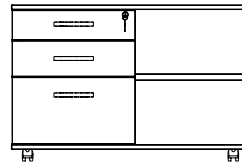

**MC1**  
900W x 570D x 600H

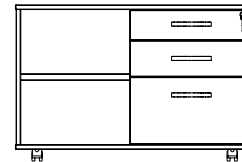

**MC2**  
900W x 570D x 600H

**MOBILE STORAGE UNITS (METAL)**



**MM1**  
390W x 520D x 600H



**MN1**  
300W x 520D x 600H

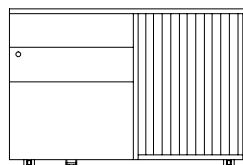

**MMC1**  
900W x 500D x 610H

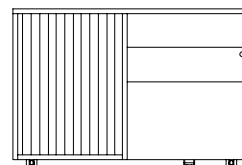

**MMC2**  
900W x 500D x 610H

**ABOVE DESK POWER / DATA**

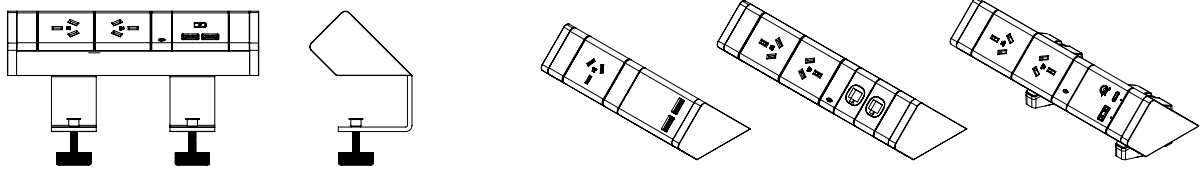

CMS Athena II

**IN-DESK POWER / DATA**

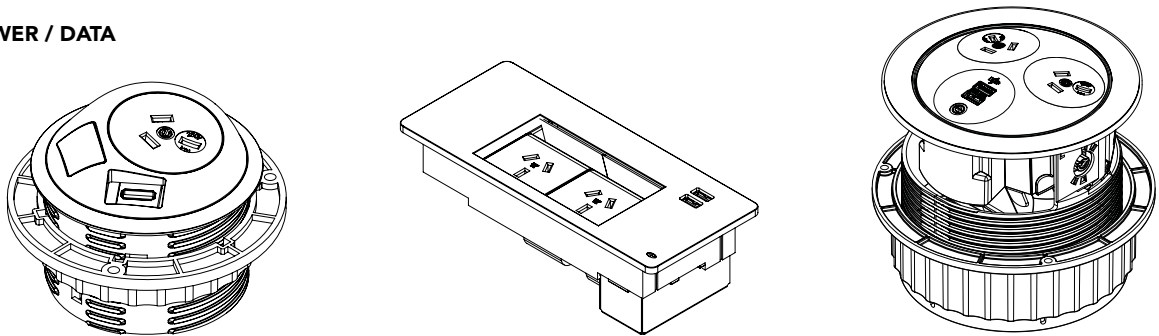

elsafe Pixel

CMS Flip

elsafe Pandora

**IN-DESK SINGLE LID POWER BOX**

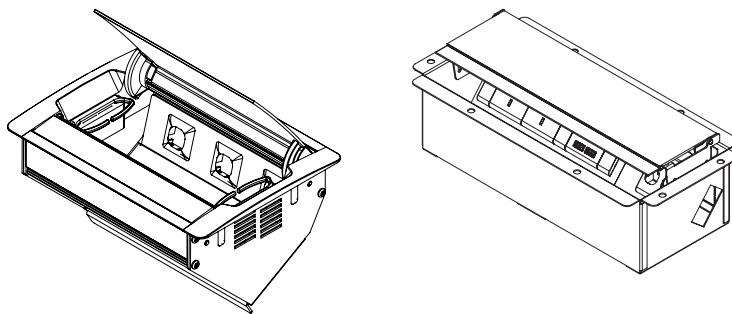

CMS Accede

CMS Executive

**WIRELESS CHARGING**



ARC-80



ARC-H



**UMBILICAL (CMS CIRQLATE)**



**SPECIFICATIONS**

Cirqlate size:	72 x 15mm
Standard length:	770 / 2100 / 2800mm
Standard colour options:	Black, Silver, Clear, White
Special colour options: (Min. quantities apply)	Aqua, Light Green, Dark Green, Dark Blue, Light Blue, Orange, Pink, Yellow and Dark Red

**CABLE BASKETS**



**SPECIFICATIONS**

Single tier, 100mm wide:	650 / 950 / 1250 / 1550 / 1750 / 2050mm
Dual tier, 100mm wide:	650 / 950 / 1250 / 1550 / 1750 / 2050mm

**MONITOR ARMS (FLO)**

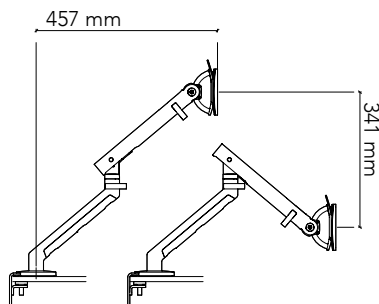

**SPECIFICATIONS**

Monitor weight range:	Max. 9kg per arm
Tilt range:	48.5° upwards, 48.5° downwards
Horizontal range:	570mm for desk clamp versions
Vertical range:	341mm
Colour:	silver, white and black
Monitor head:	VESA 75 & 100 compliant
Fixing options:	1. Split clamp 2. Dual split clamp 3. Through desk kit

**MONITOR ARMS (C.ME)**

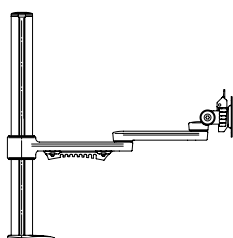

**SPECIFICATIONS**

Monitor weight range:	Max. 8kg per arm
Post height (standard):	430mm
Adjustment range:	330mm
Post height (long):	740mm
Adjustment range:	695mm
Horizontal range:	445mm
Colour:	white, polished and black
Monitor head:	VESA compliant

**FEATURE RAIL**

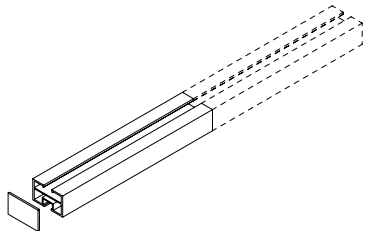

**SPECIFICATIONS**

Height:	24.5mm
Width:	40mm
Accessories:	Planter box Storage box Divider screen Melamine shelf
Finishes	Brushed aluminium (Standard) Powder coated (Special request)

**PLANTER BOX (FEATURE RAIL MOUNT)**

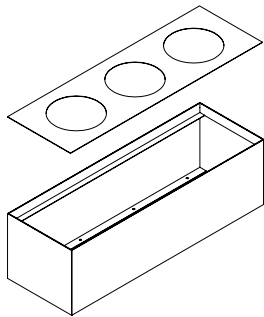

**SPECIFICATIONS**

Standard width:	600 / 900 / 1200mm
Standard depth:	200mm
Standard height:	175mm
Style:	Solid / Perforated
Colour:	White (standard)
Colour options:	Powder Coat Range

**DIVIDER SCREEN (FEATURE RAIL MOUNT)**



**SPECIFICATIONS**

Standard width:	600 / 900 / 1200mm
Standard height:	300 / 400 / 500mm
Material options:	1. Perspex Panel (8mm) 2. Ecooustic Panel (12mm) 3. Ecooustic Panel Dual Layer (24mm) 4. Laminate Panel (16mm) 5. Fabric Panel (16mm) 6. Fabric Panel Dual Layer (32mm)

**STORAGE BOX (FEATURE RAIL MOUNT)**

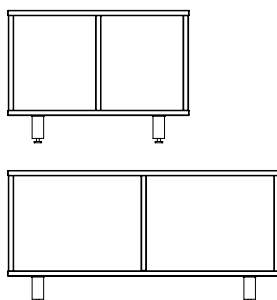

**SPECIFICATIONS**

Standard width:	600 / 900mm
Standard height:	350mm
Material:	Melamine
Style options:	1. Open storage box (without back panel) 2. Semi-open storage box (with back panel)

**MELAMINE SHELF (FEATURE RAIL MOUNT)**

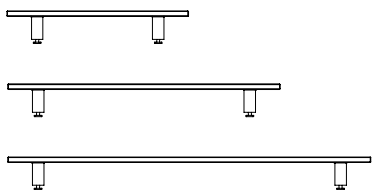

**SPECIFICATIONS**

Standard width: 600 / 900 / 1200mm  
 Standard depth: 300mm  
 Colour options: Please refer Finishes - Boards - Group 1

**DIVIDER SCREEN (SLIDE ON)**

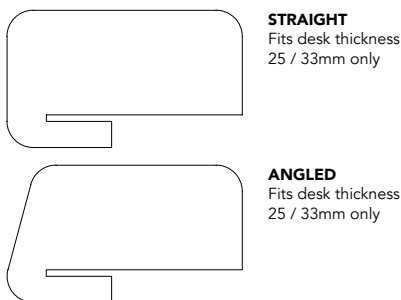

**STRAIGHT**  
Fits desk thickness  
25 / 33mm only

**ANGLED**  
Fits desk thickness  
25 / 33mm only

**SPECIFICATIONS**

Standard width: 850W / 900W / 950W  
 Standard height: 300H / 400H / 480H  
 Material options:  
 1. Ecoustic Panel (24mm)  
 2. Melamine Panel (25 / 32mm)  
 3. Fabric Wrapped Panel (40mm)

**ENVY SCREEN (DESK MOUNT)**

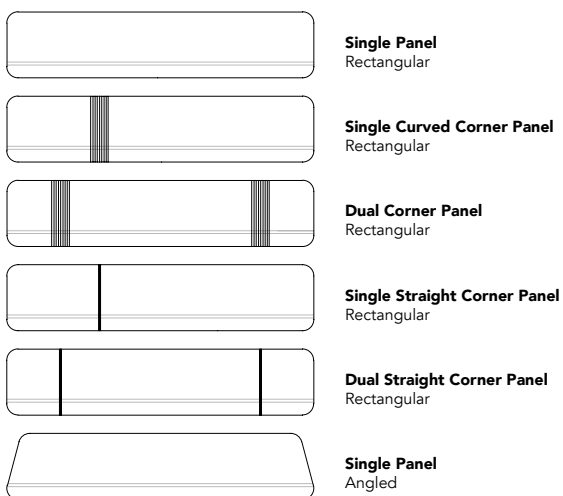

**Single Panel**  
Rectangular

**Single Curved Corner Panel**  
Rectangular

**Dual Corner Panel**  
Rectangular

**Single Straight Corner Panel**  
Rectangular

**Dual Straight Corner Panel**  
Rectangular

**Single Panel**  
Angled

**SPECIFICATIONS**

Material options:  
 1. Ecoustic Panel (12mm)  
 2. Ecoustic Panel Dual Layer (24mm)  
 3. Fabric Wrapped Ecoustic Panel (35mm)

Single Panel	Standard Width	Standard Height
Rectangular	600mm - 2750mm	490mm - 590mm
Angled	900mm - 2750mm	
Single Curved / Straight Corner Panel (12mm only)		
Rectangular	1200mm - 2750mm	490mm - 590mm
Angled	1200mm - 2750mm	
Dual Curved / Straight Corner Panel (12mm only)		
Rectangular	1800mm - 2750mm	490mm - 590mm
Angled	2000mm - 2750mm	

**CPU HOLDER (CPU60)**

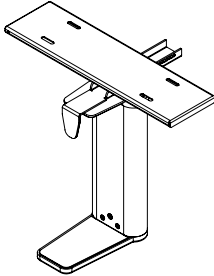

**SPECIFICATIONS**

Max. weight capacity:	10kg
Min. CPU size:	270mm x 75mm
Max. CPU size:	370mm x 200mm
Colour options:	White, Silver & White

**CPU HOLDER (THIN CLIENT)**

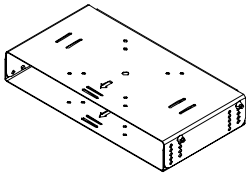

**SPECIFICATIONS**

Max. weight capacity:	12kg
Thickness range:	38mm - 67mm
Min. width:	274mm
Max. height:	255mm
Colour options:	Black

**CPU HOLDER (LOOP)**



**SPECIFICATIONS**

Max. weight capacity:	20kg
Min. CPU size:	275mm x 90mm
Max. CPU size:	550mm x 225mm
Colour options:	Black

**KEYBOARD LOZENGE (METAL)**

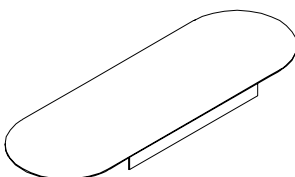

**SPECIFICATIONS**

Overall size:	600W x 200D (mm)
Min. worktop thickness:	25mm
Max. worktop thickness:	33mm
Colour options:	Powder Coat Range

# Finishes - Boards - Group 1 (Laminex).

Please refer to a physical sample.  
Colours are for an indicative reference only.  
Actual colour and finish may vary slightly.

## Solids

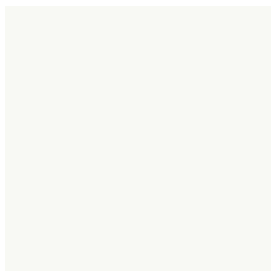

Polar White

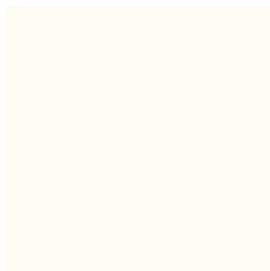

White

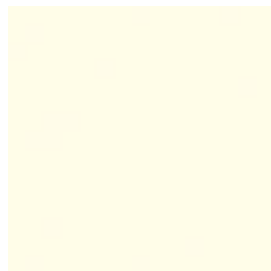

Parchment



Oyster Grey



Fox



Tornado

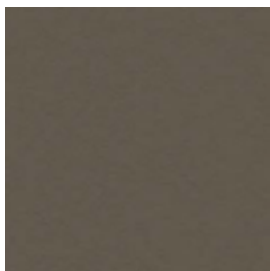

Fossil

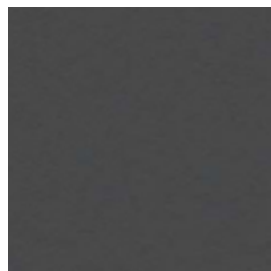

Battalion

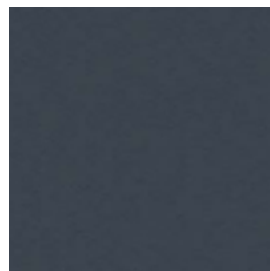

Charcoal

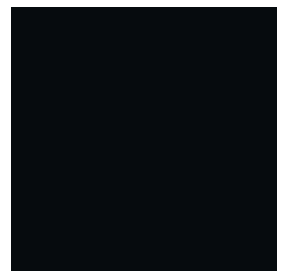

Black

## Patterns



Zincworks



New Graphite

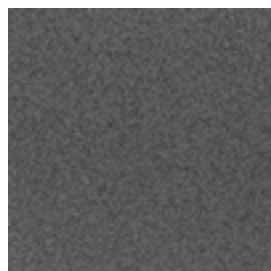

Ironstone

# Finishes - Boards - Group 1 (Laminex).

Please refer to a physical sample.  
Colours are for an indicative reference only.  
Actual colour and finish may vary slightly.

## Woodgrains

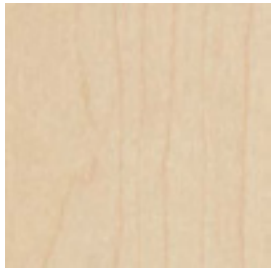

Dansk Maple

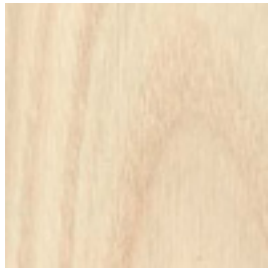

Milkwood



Seasoned Oak

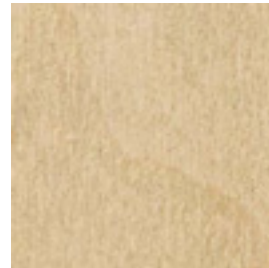

Raw Birchply



Curly Birch



Young Beech

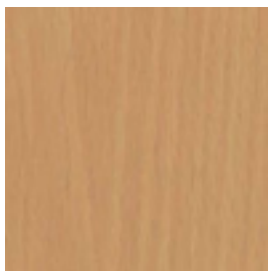

Select Beech

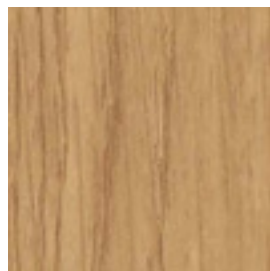

Elegant Oak

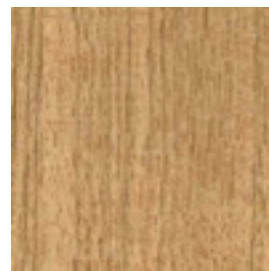

Sublime Teak

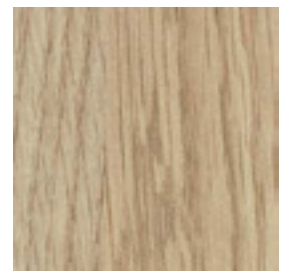

Classic Oak



Rural Oak



Alaskan

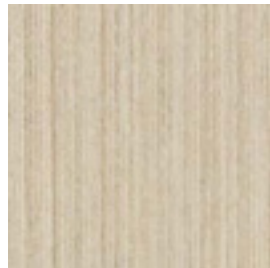

Oyster Linea

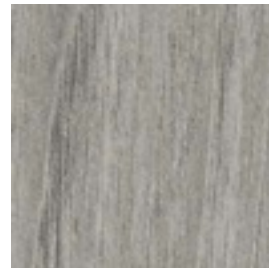

Fox Teakwood



Lustrous Elm

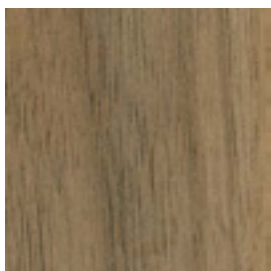

Natural Walnut

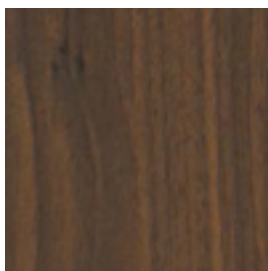

Milano Walnut

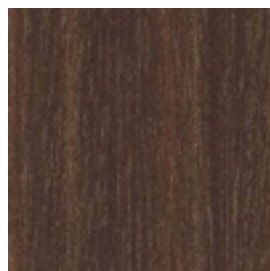

Jarraah Legno

## Finishes - Boards - Group 1 (Polytec).

Please refer to a physical sample.  
Colours are for an indicative reference only.  
Actual colour and finish may vary slightly.

---

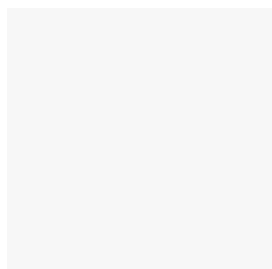

Polar White

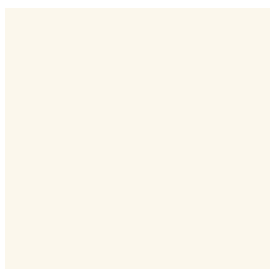

Natural White

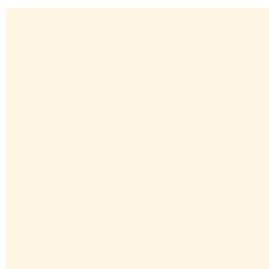

Parchment

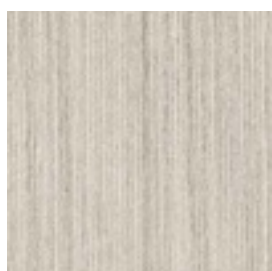

Marni Lini

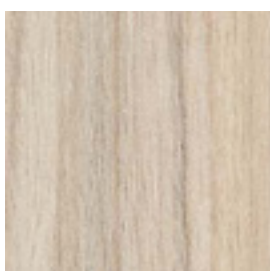

Soft Walnut

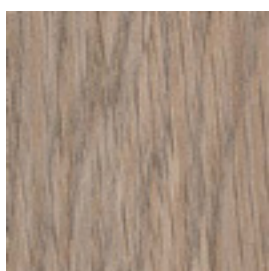

Maison Oak

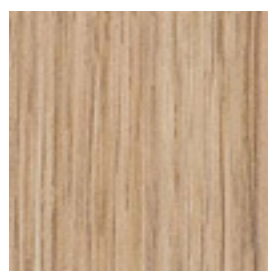

Natural Oak

# Powder Coat Range.

Please refer to a physical sample.  
Colours are for an indicative reference only.  
Actual colour and finish may vary slightly.

Standard

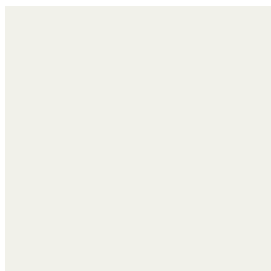

Satin White

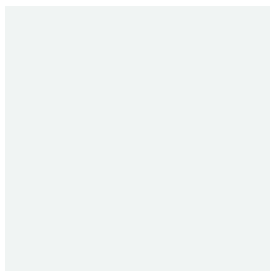

Pearl White

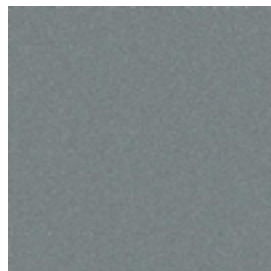

Precious Silver Pearl

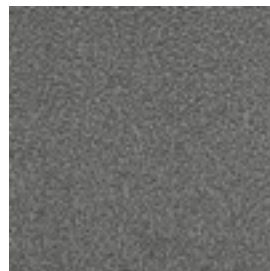

Graphite Ripple

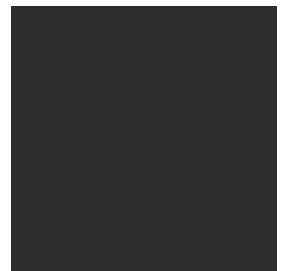

Black

Extended

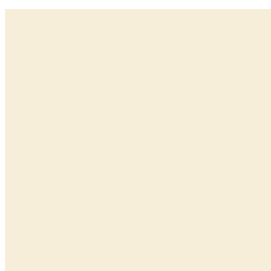

White Birch

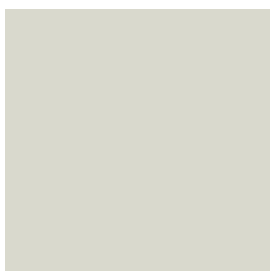

Off White



Stromboli



Deep Ocean

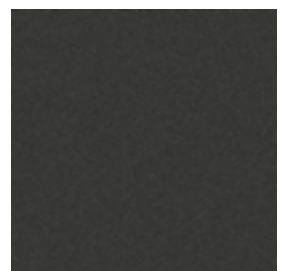

Gunmetal Kinetic Pearl



Lemon Yellow



Orange X15



Signal Red



Blaze Blue



Champagne Kinetic Pearl



Stone Grey



Wedgewood

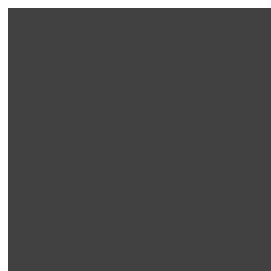

Monument

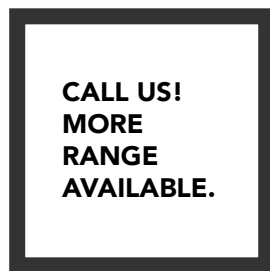



# Screen Fabric.

Please refer to a physical sample.  
Colours are for an indicative reference only.  
Actual colour and finish may vary slightly.

Suzette

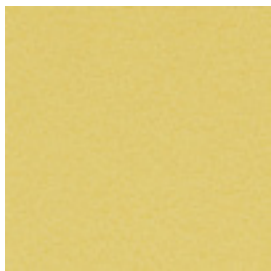

Limone

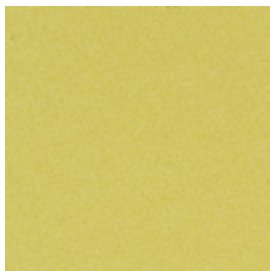

Splice

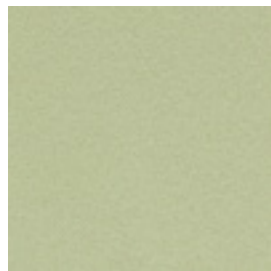

Pistachio

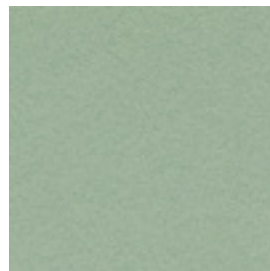

Mint



Celery

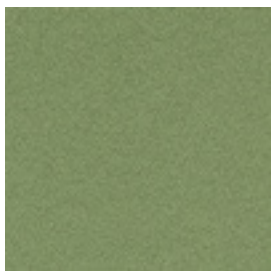

Decor

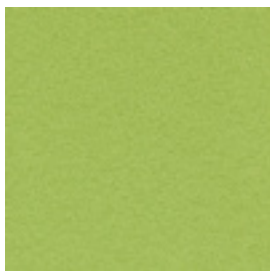

Citrus

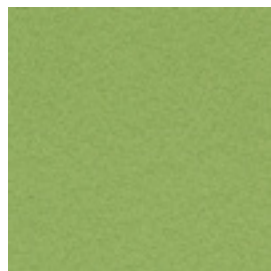

Opal

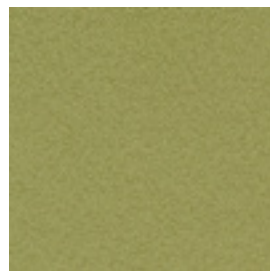

Lucerne

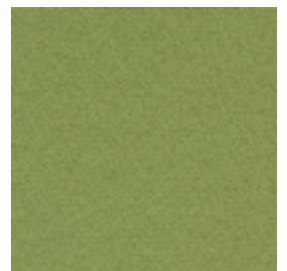

Hula

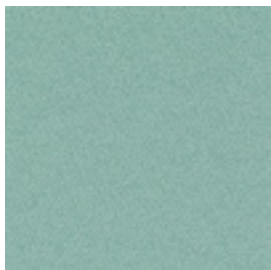

Humbug

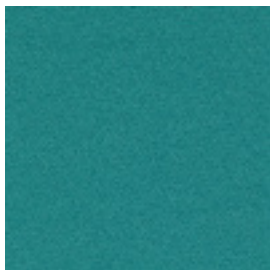

Joker



Mainsail

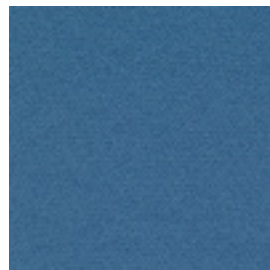

Luxury



Olympia

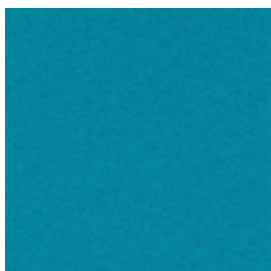

Cyan

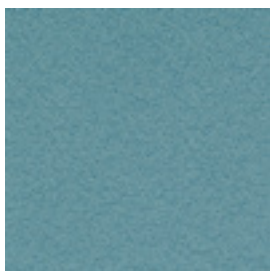

Tiffany

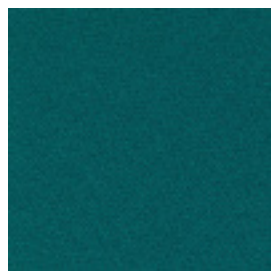

Aero

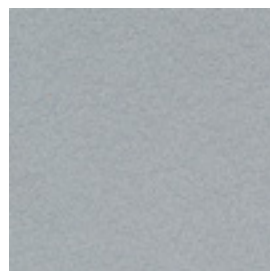

Iris



Dolphin

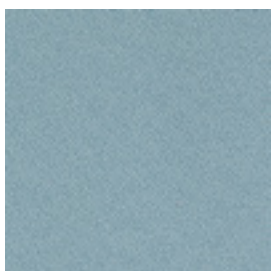

Twist

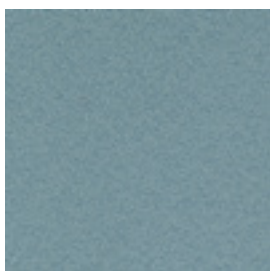

Heaven

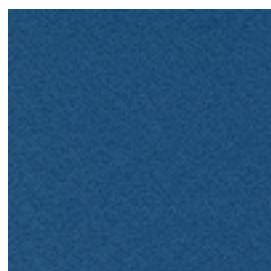

Conquest

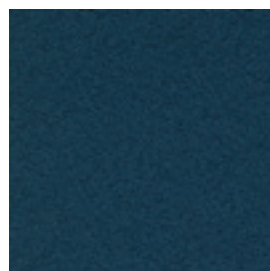

Octane



Blizzard

# Screen Fabric.

Please refer to a physical sample.  
Colours are for an indicative reference only.  
Actual colour and finish may vary slightly.

Suzette

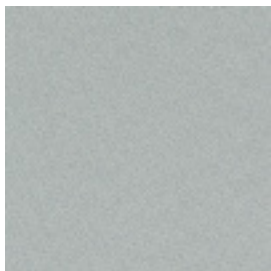

Tequila

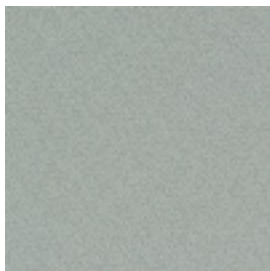

Pavement

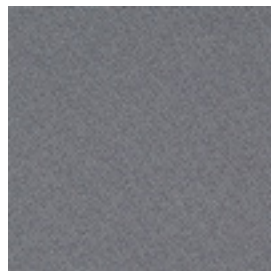

Spire

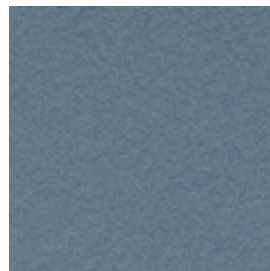

Periwinkle



Nimble

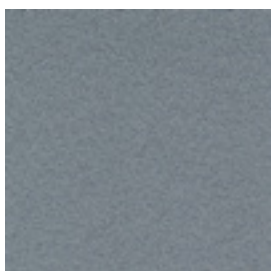

Shadow

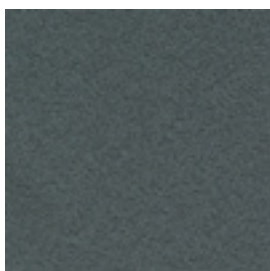

Sinker

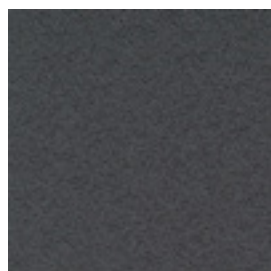

Stormcloud

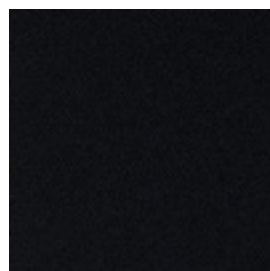

Stallion

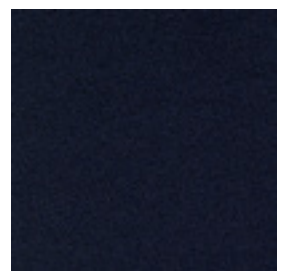

Popeye

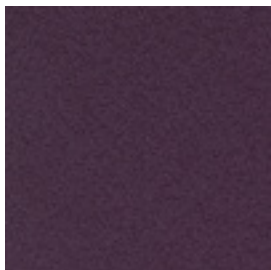

Mulberry



Pizzazz

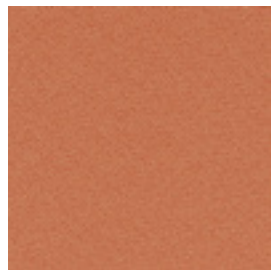

Vibrant

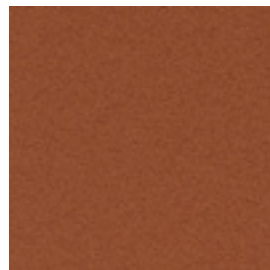

Russet



Gala

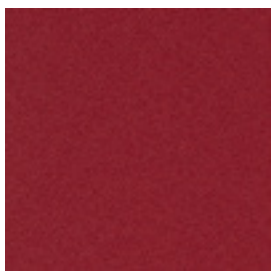

Rosso

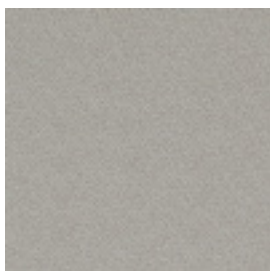

Organic

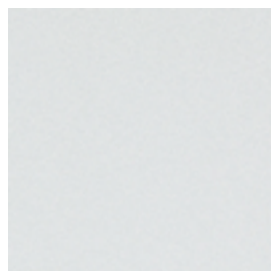

White

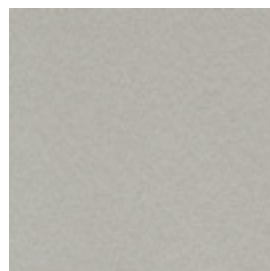

Eggshell



Ivory

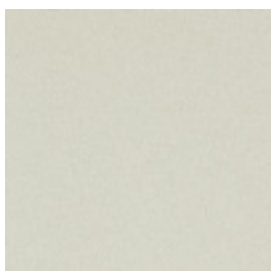

Ice cream

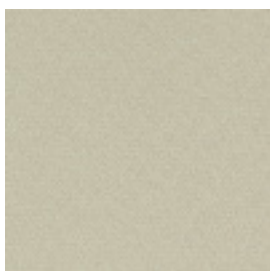

Neutral

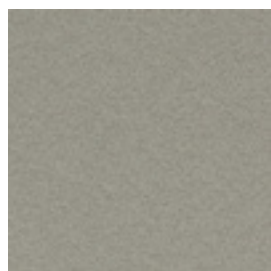

Cafe

# Screen Fabric.

Please refer to a physical sample.  
Colours are for an indicative reference only.  
Actual colour and finish may vary slightly.

Trilogy I



Glacier



Polar



Icecap

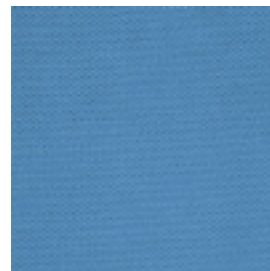

Bluebell



Jade

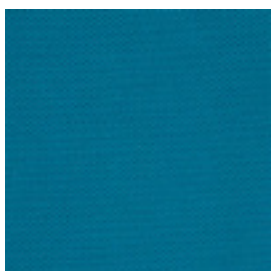

Teal

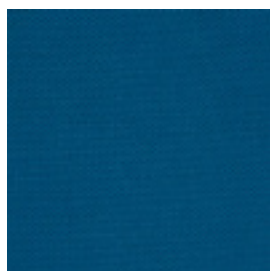

Ink

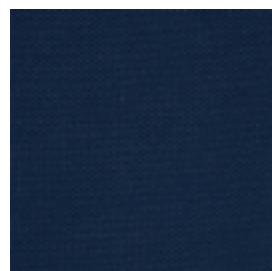

Cobalt

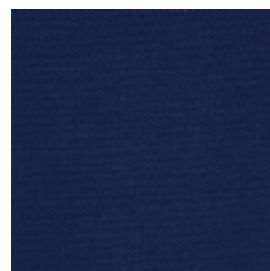

Indigo



Emerald



Hydra

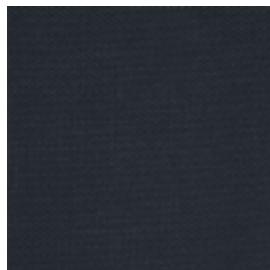

Oxide

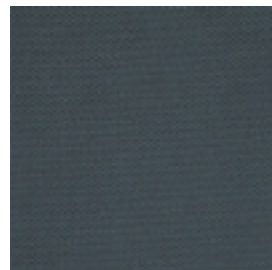

Smoke

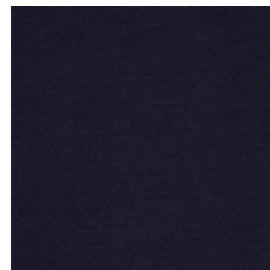

Midnight



Ocean

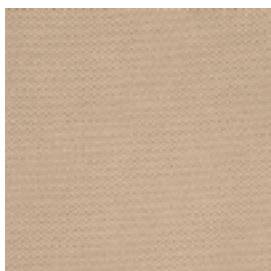

Stone

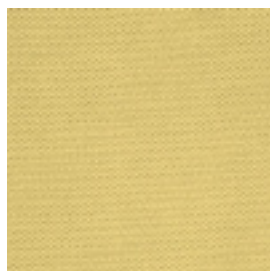

Banana

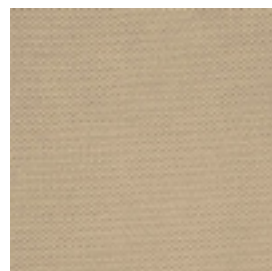

Putty

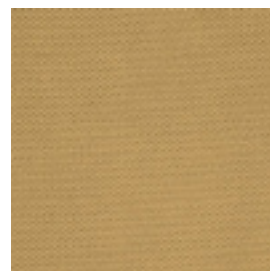

Barley



Chrome



Daffodil

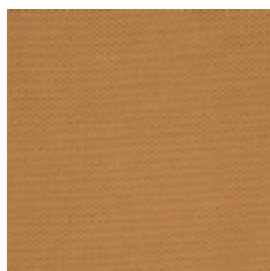

Gold



Lime



Sage



Forest



# Screen Fabric.

Please refer to a physical sample.  
Colours are for an indicative reference only.  
Actual colour and finish may vary slightly.

Trilogy I



Paw Paw

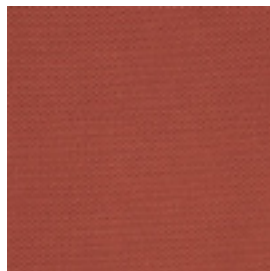

Sienna



Flame

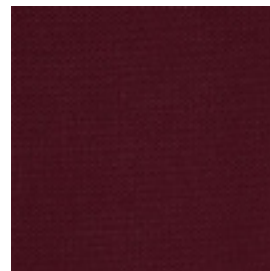

Wine



Loden

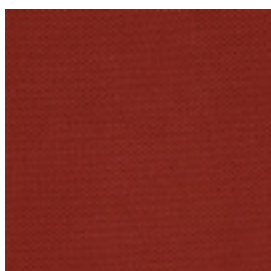

Henna

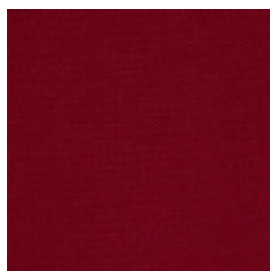

Cherry



Tangerine

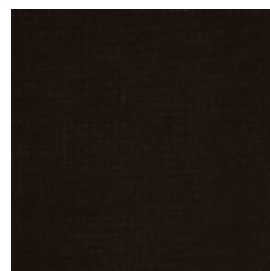

Chocolate

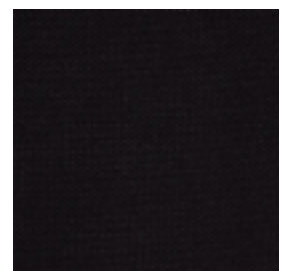

Black



Lavender

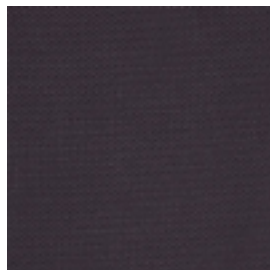

Aubergine

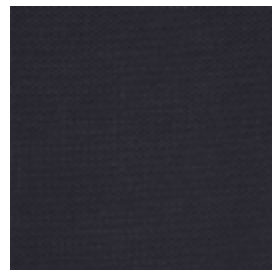

Charcoal



Battleship



Dove



Dust



Misty

# Finishes - Ecooustic.

Please refer to a physical sample.  
Colours are for an indicative reference only.  
Actual colour and finish may vary slightly.

12mm Thick

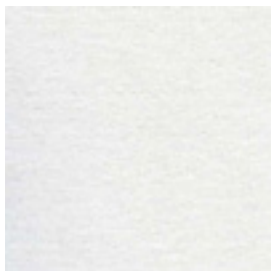

Snowdrop

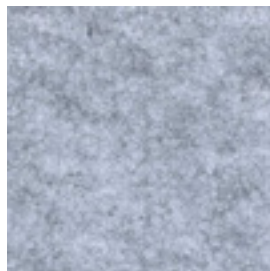

Oxide



Cool



Tungsten

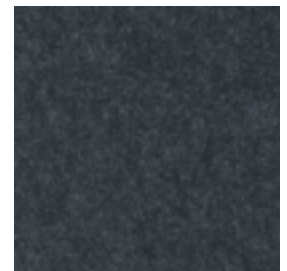

Galaxy

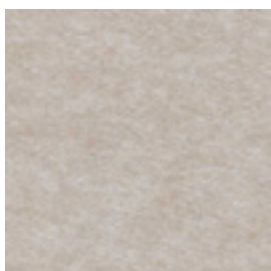

Almond



Arizona

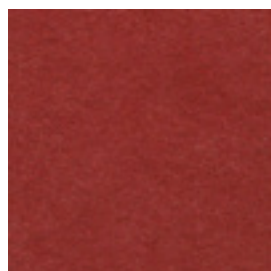

Venus

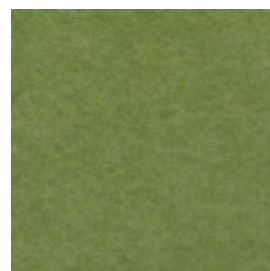

Leaf

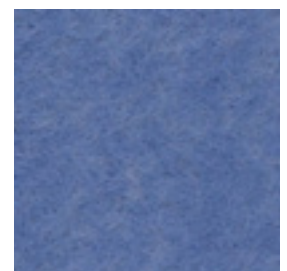

Bluebell

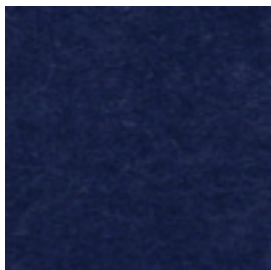

Iris

24mm Thick

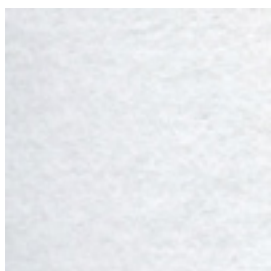

Pure

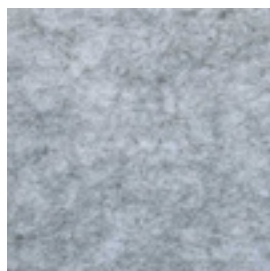

Stone

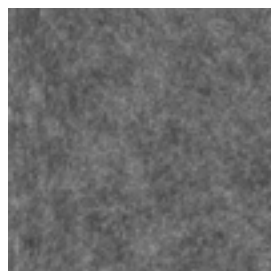

Ash

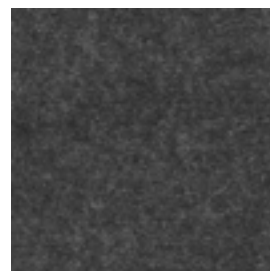

Graphite

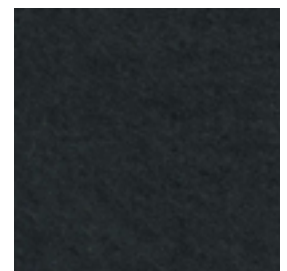

Nero

## WATTS COMMERCIAL FURNITURE AND THE ENVIRONMENT

Watts Commercial Furniture (WCF) manufactures a wide range of high quality commercial furniture for Government departments (Commonwealth, State and Local) and corporate organisations. WCF is a one stop shop where we design, manufacture and install all of our systems and products.

We conduct our business with due concern and protection of the natural environment which includes biodiversity and ecosystems. Our Environmental Policy is a statement of commitment from Management and reflects the values and ethos of the company.

It is our intention to maintain a sustainable, environmentally responsible business which respects the quality of the environment and uses resources efficiently.

To that end, we are committed to:

- Complying with environmental laws and regulation.
- Complying with AFRDI Green Tick Certification.
- Understanding market expectations and industry trends.
- Consideration of environmental issues in business strategies and initiatives
- Reducing pollution.
- Recycling and material minimization whenever possible.
- Implementing energy efficient practices.
- Setting environmental objectives.
- Creating an awareness of environmental issues through ongoing education and training.
- Promoting sustainability awareness within our supply chain.
- Taking a life cycle approach for product design, manufacturer and end of life.
- Striving for continual improvement to enhance environmental performance.

Our company's commitment extends to operating in accordance with the International standard's ISO 14001: 2015 (EMS).

**PAT LETO**



**Chief Executive Officer** 01 April 2019



## QUALITY COMMITMENT

Watts Commercial Furniture (WCF) manufactures and supplies a wide range of high quality commercial furniture to Government Departments and Corporate Organisations. WCF is a one stop shop where we design, manufacture and install all of our systems and products.

All members of the organisation are actively involved in the process of continuous improvement, which is monitored against measureable objectives. We do this by ensuring the implementation and ongoing improvement of an Integrated Management System of processes and procedures to reduce risk, exploit opportunities, in the company's commitment to meeting its customer needs and expectations.

Our quality objectives include striving for continual improvement in our systems, products and services through on-going staff training and development; seeking and responding to customer feedback; and through providing a world's best practice safe working environment.

We also constantly seek advancement by ensuring the implementation and ongoing improvement of a Management System of processes and procedures that serve to reduce risk and exploit opportunities. Through our Quality Management System conforming to ISO 9001:2015, we constantly seek to improve the quality of our products and services, in line with evolving management considerations and requirements.

We also seek to preserve our well-earned reputation for providing high levels of service to our customers, coupled with optimum quality products, at competitive prices and market leading minimal lead times. WCF also provides our customers with value added support and backup that they can depend on.

**PAT LETO**



**Chief Executive Officer** 01 April 2019





Watts Commercial Furniture  
350a Edgar St  
Bankstown NSW 2200

p: 02 9771 3966  
f: 02 9771 6824

sales.watts@wcf.com.au  
accounts.watts@wcf.com.au

**[www.wcf.com.au](http://www.wcf.com.au)**

Watts Commercial Furniture reserves the right to change any or all details without prior notice. Every effort has been made to ensure the information is accurate at the time of printing.

March 2020