



## MOBILE STORAGE UNITS

storage

### Features

- Lockable for extra level of security
- Designed & Manufactured in Australia
- Heavy duty grade castors
- Wide range of colour options
- Two-tone colour option available
- Other sizes / configurations available on request

WARRANTY

**10**  
Year

# Contents

## **Mobile Storage Units.**

Mobile Drawer.	p.3 - p.4
Mobile Caddy.	p.5
Mobile Bedside Cabinet.	p.6

# MOBILE STORAGE UNITS.

mobile drawer

# Watts.

## MD5

Unit Size: 470W x 570D x 510H  
Drawers: 2 (1 x Personal + 1 x File)  
Weight Capacity: 10 kg (Personal drawer)  
25 kg (File drawer)  
Lock: Gang Lock  
Colour: Group 1 (standard)  
Colour Option 1: Group 2  
Colour Option 2: Two-tone  
Anti-Tilt feature: 5th wheel

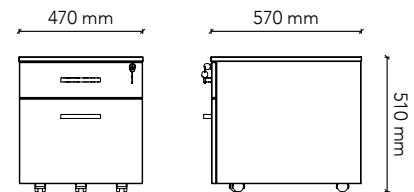

## MD6

Unit Size: 470W x 570D x 510H  
Drawers: 3 x Personal Drawer  
Weight Capacity: 10 kg (Personal drawer)  
Lock: Gang Lock  
Colour: Group 1 (standard)  
Colour Option 1: Group 2  
Colour Option 2: Two-tone

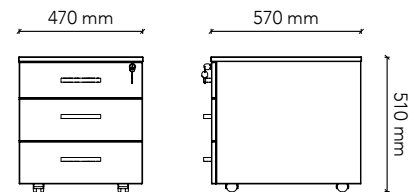

## MD7

Unit Size: 470W x 570D x 650H  
Drawers: 3 (2 x Personal + 1 x File)  
Weight Capacity: 10 kg (Personal drawer)  
25 kg (File drawer)  
Lock: Gang Lock  
Colour: Group 1 (standard)  
Colour Option 1: Group 2  
Colour Option 2: Two-tone  
Anti-Tilt feature: 5th wheel

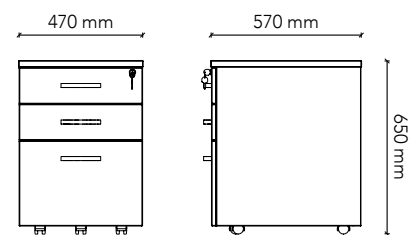

## MD8

Unit Size: 470W x 570D x 690H  
Drawers: 2 x File Drawer  
Weight Capacity: 25 kg (File drawer)  
Lock: Gang Lock  
Colour: Group 1 (standard)  
Colour Option 1: Group 2  
Colour Option 2: Two-tone  
Anti-Tilt feature: 5th wheel

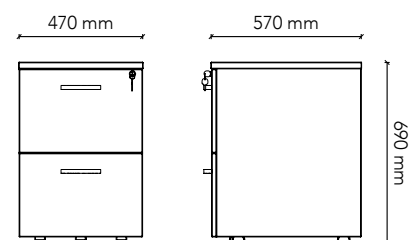

# MOBILE STORAGE UNITS.

mobile drawer



## MD9

Unit Size: 470W x 570D x 650H  
Drawers: 4 x Personal Drawer  
Weight Capacity: 10 kg (Personal drawer)  
Lock: Gang Lock  
Colour: Group 1 (standard)  
Colour Option 1: Group 2  
Colour Option 2: Two-tone

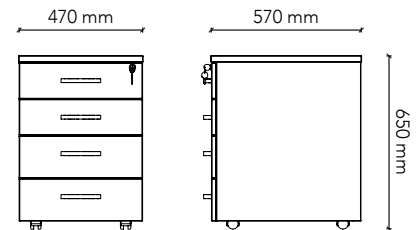

## MD10

Unit Size: 470W x 570D x 600H  
Drawers: 3 (1 x Pencil + 1 x Personal + 1 x File)  
Weight Capacity: 10 kg (Pencil drawer)  
10 kg (Personal drawer)  
25 kg (File drawer)  
Lock: Gang Lock  
Colour: Group 1 (standard)  
Colour Option 1: Group 2  
Colour Option 2: Two-tone  
Anti-Tilt feature: 5th wheel

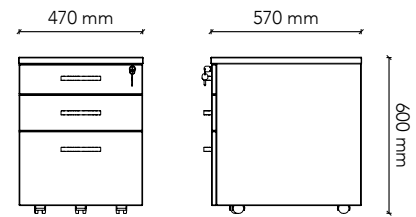

# MOBILE STORAGE UNITS.

mobile caddy

# Watts.

## MC1

Unit Size: 900W x 570D x 600H  
Drawers: 3 - LH  
Storage: Open storage - RH  
Weight Capacity: 10 kg (Personal drawer)  
25 kg (File drawer)  
30 kg (Shelf)  
Lock: Gang Lock  
Colour: Group 1 (standard)  
Colour Option 1: Group 2  
Colour Option 2: Two-tone

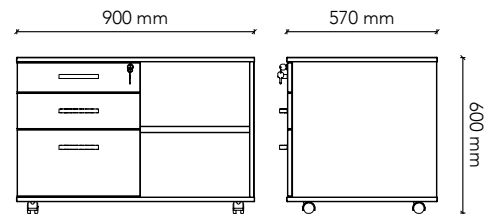

## MC2

Unit Size: 900W x 570D x 600H  
Drawers: 3 - RH  
Storage: Open storage - LH  
Weight Capacity: 10 kg (Personal drawer)  
25 kg (File drawer)  
30 kg (Shelf)  
Lock: Gang Lock  
Colour: Group 1 (standard)  
Colour Option 1: Group 2  
Colour Option 2: Two-tone

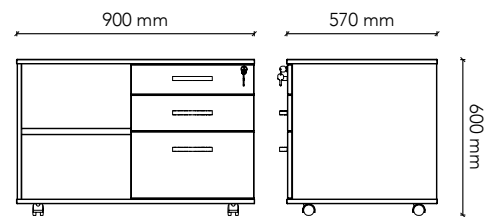

## MCT3

Unit Size: 900W x 570D x 600H  
Drawers: 3 - LH  
Storage: Tambour door - RH  
Weight Capacity: 10 kg (Personal drawer)  
25 kg (File drawer)  
30 kg (Shelf)  
Lock: Gang Lock  
Colour: Group 1 (standard)  
Colour Option 1: Group 2  
Colour Option 2: Two-tone

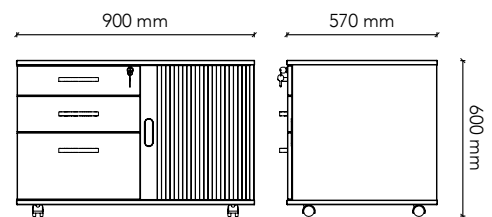

## MCT4

Unit Size: 900W x 570D x 600H  
Drawers: 3 - RH  
Storage: Tambour door - LH  
Weight Capacity: 10 kg (Personal drawer)  
25 kg (File drawer)  
30 kg (Shelf)  
Lock: Gang Lock  
Colour: Group 1 (standard)  
Colour Option 1: Group 2  
Colour Option 2: Two-tone

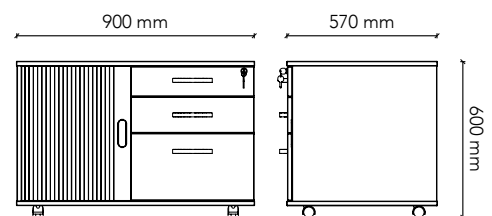

# MOBILE STORAGE UNITS.

mobile bedside cabinet



## MD11

Unit Size: 450W x 570D x 1000H  
Drawers: 1 x Top Drawer  
2 x Dump Drawer  
Lock: Gang Lock  
Colour: Group 1 (standard)  
Colour Option 1: Group 2  
Colour Option 2: Two-tone

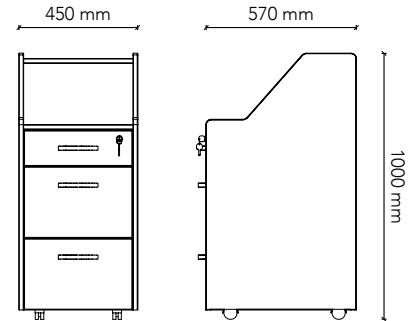

## MD12

Unit Size: 460W x 500D x 910H  
Drawers: 1 x Top Drawer  
2 x Dump Drawer  
Lock: Gang Lock  
Colour: Group 1 (standard)  
Colour Option 1: Group 2  
Colour Option 2: Two-tone

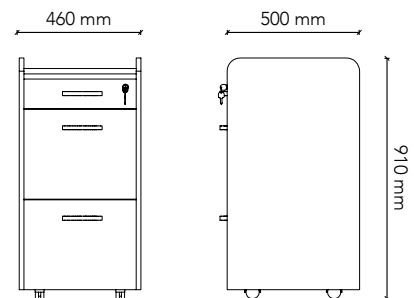

**Watts.**  
Quality furniture since 1922



Watts Commercial Furniture  
350a Edgar St  
Bankstown NSW 2200

p: 02 9771 3966  
f: 02 9771 6824

sales.watts@wcf.com.au  
accounts.watts@wcf.com.au

**[www.wcf.com.au](http://www.wcf.com.au)**

Watts Commercial Furniture reserves the right to change any or all details without prior notice. Every effort has been made to ensure the information is accurate at the time of printing.

August 2019