



VOLTARÉ

workstations

Features

- Affordable electric Sit to Stand system
- Available in straight desk & corner layout
- Electric height adjustable range from 610 - 1260mm
- 4 Favourite positions memory
- Control height with your iOS or Android device via desk control apps
- Wide range of tabletop colour options
- Other sizes / configurations available on request

WARRANTY

10
Year

Contents.

VOLTARÉ WORKSTATION.

Specifications - Overview	p.3
Specifications - Frame / Top	p.4
Options - Excess Cable / Feature Rail	p.5
Options - Screen	p.6
Options - System 50 / 75 Screen	p.7
Options - Power / Data	p.10
Options - Mobile Storage	p.11
Options - CPU Holder	p.12
Options - Cable Management / Monitor Arm	p.13

FINISHES.

Boards - Group 1 (Laminex - Solid / Patterns)	p.14
Boards - Group 1 (Laminex - Woodgrains)	p.15
Boards - Group 1 (Polytec)	p.16
Boards - Veneer Range	p.17
Screen Fabric - Suzette	p.18
Screen Fabric - Trilogy	p.20
Ecoustic Screen	p.22
Screen Frame - Powder Coat Range	p.23

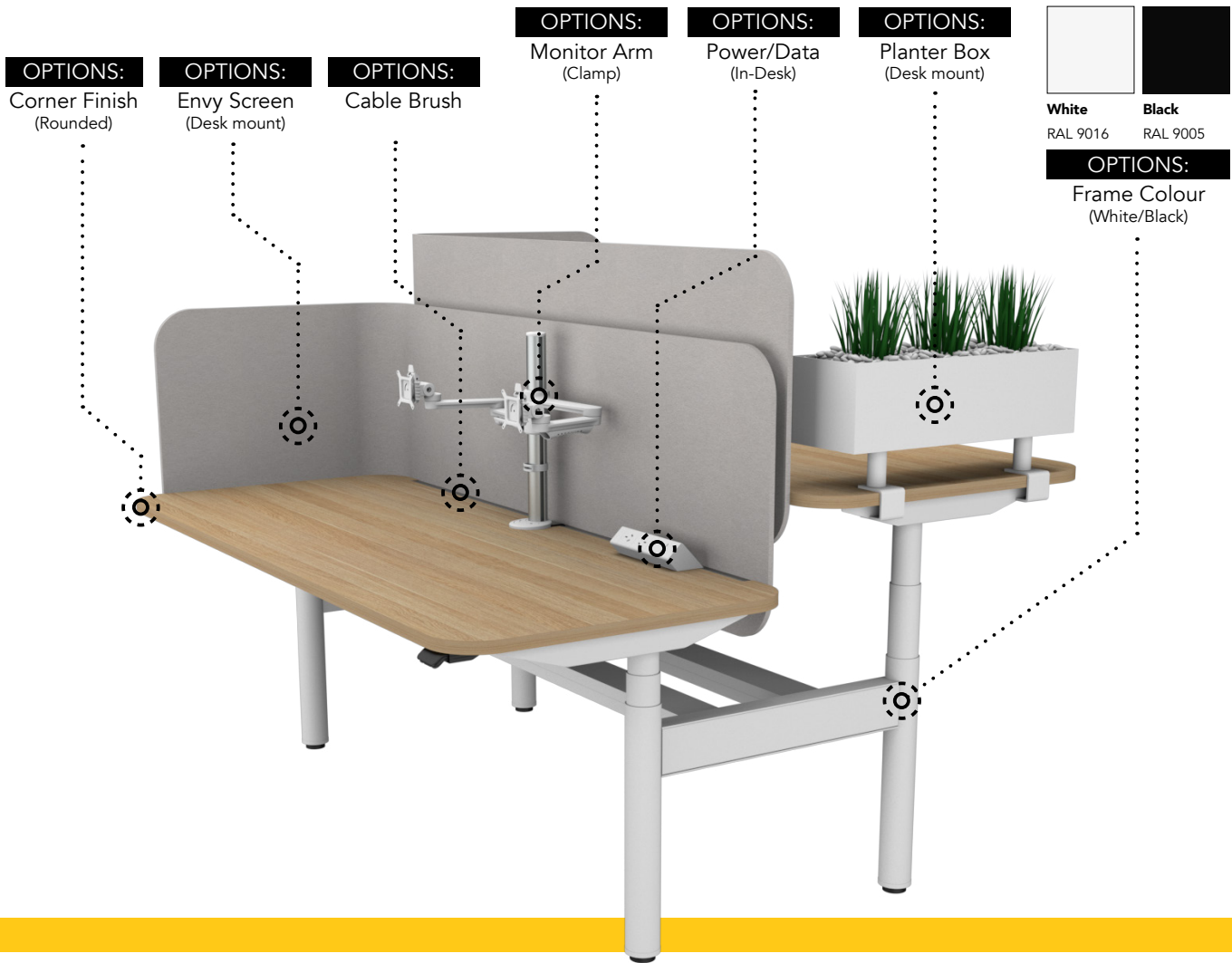

Voltaré

WORKSTATIONS

The Voltaré workstation is an affordable electric height adjustable sit to stand system. Height limits from 610 - 1260mm. Travel speed 38mm/s. It is available with optional screens in a range of materials and colours.

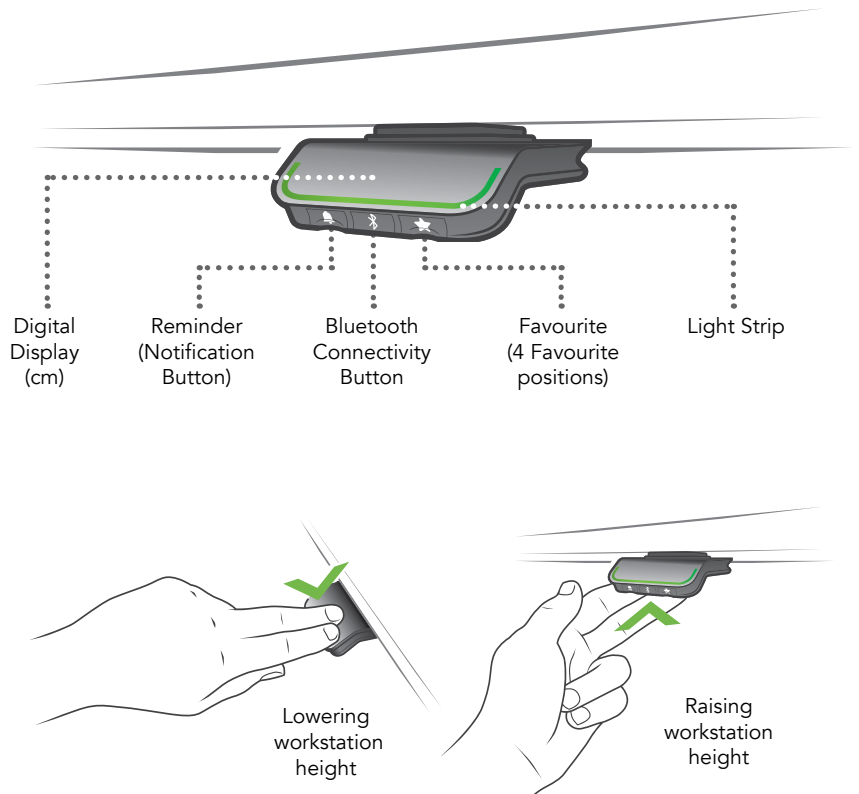

LEG RANGE

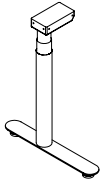

Voltaré Leg 600
For table depth 600 - 750

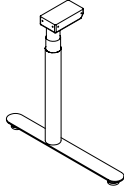

Voltaré Leg 700
For table depth 750 - 900

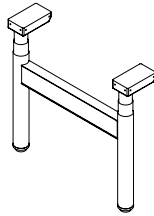

Voltaré H-Frame

FRAME COLOUR



Black
RAL 9005

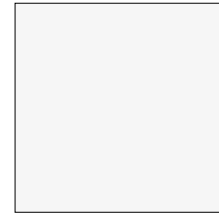

White
RAL 9016

NOTES:
Other colours available on request.
MOQ apply

STANDARD WORKTOPS SIZES

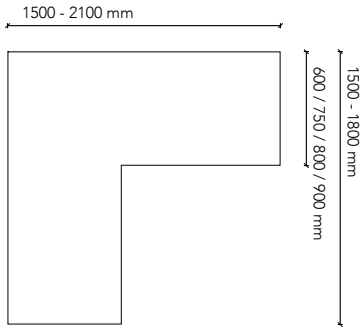

Standard 90° corner desk (1 piece)
*one side MAX. 1800mm

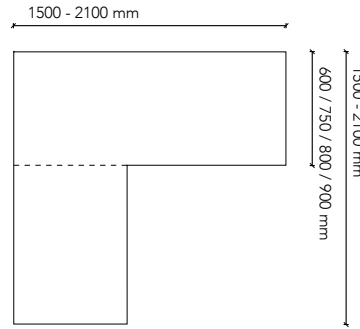

Standard 90° corner desk (2 pieces)

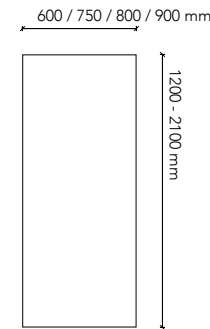

Standard rectangular desk

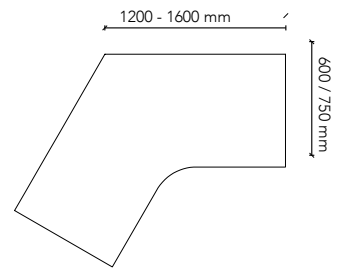

Standard 120° desk

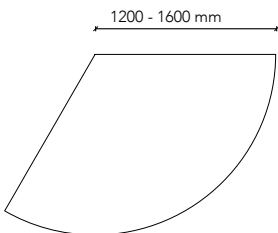

Standard 120° cluster

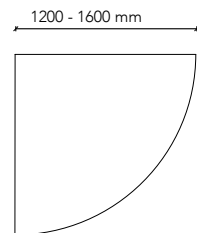

Standard 90° cluster

WORKTOPS EDGE / CORNER FINISH OPTIONS

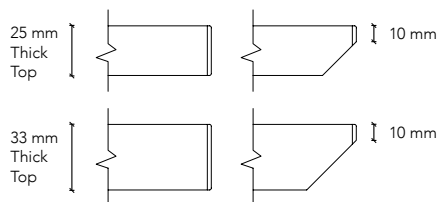

Square (Standard)

Sharknose

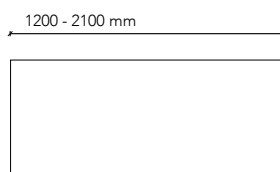

Square corners (Standard)

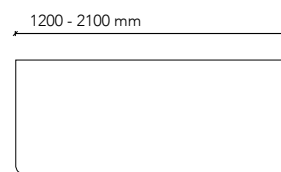

50 or 100 mm radius to front corners

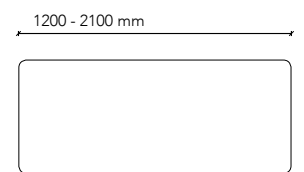

50 or 100 mm radius to all corners

EXCESS CABLES - CUTOUT

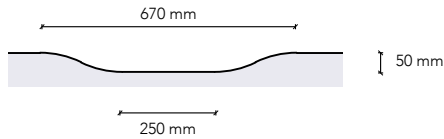

Large Scallop

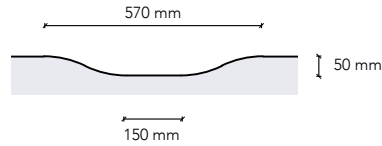

Small Scallop

EXCESS CABLES - CABLE BRUSH / CABLE FLAPS

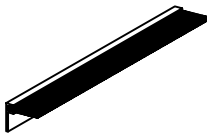

Standard Cable Brush

Must be specified with the worksurface

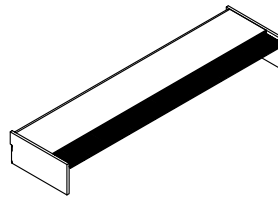

Standard Cable Flaps

Must be specified with the worksurface

FEATURE RAIL

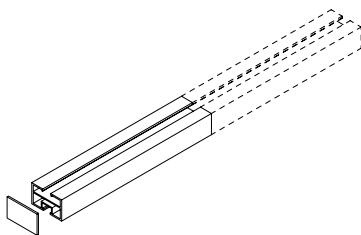

SPECIFICATIONS

Height:	24.5mm
Width:	40mm
Accessories:	Divider screen
Finishes	Brushed aluminium (Standard) Powder coated (Special request)

DIVIDER SCREEN (FEATURE RAIL MOUNT)



SPECIFICATIONS

Standard width:	600 / 900 / 1200mm
Standard height:	300 / 400 / 500mm
Material options:	1. Perspex Panel (8mm) 2. Ecooustic Panel (12mm) 3. Ecooustic Panel Dual Layer (24mm) 4. Laminate Panel (16mm) 5. Fabric Panel (16mm) 6. Fabric Panel Dual Layer (32mm)

BANKSIA SCREEN (FIXED TO SYSTEM FRAME)



SPECIFICATIONS

Standard width: 1200 - 2100mm
 Standard height: 900 - 1500mm AFFL
 Material: Fabric Wrapped Screen (35mm)
 Style options:
 1. Single tone
 2. Two tone
 3. Quilted upholstery detail

DIVIDER SCREEN (SLIDE ON)

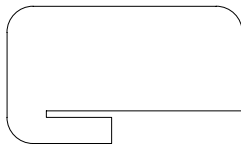

STRAIGHT
 Fits desk thickness
 25 / 33mm only

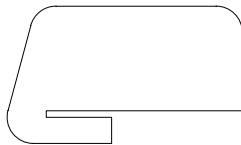

ANGLED
 Fits desk thickness
 25 / 33mm only

SPECIFICATIONS

Standard width: 850W / 900W / 950W
 Standard height: 300H / 400H / 480H
 Material options:
 1. Ecoustic Panel (24mm)
 2. Melamine Panel (25 / 32mm)
 3. Fabric Wrapped Panel (40mm)

ENVY SCREEN (DESK MOUNT)



Single Panel
 Rectangular



Single Curved Corner Panel
 Rectangular



Dual Corner Panel
 Rectangular



Single Straight Corner Panel
 Rectangular



Dual Straight Corner Panel
 Rectangular



Single Panel
 Angled

SPECIFICATIONS

Material options:
 1. Ecoustic Panel (12mm)
 2. Ecoustic Panel Dual Layer (24mm)
 3. Fabric Wrapped Ecoustic Panel (35mm)

Single Panel	Standard Width	Standard Height
Rectangular	600mm - 2750mm	490mm - 590mm
Angled	900mm - 2750mm	
Single Curved / Straight Corner Panel (12mm only)		
Rectangular	1200mm - 2750mm	490mm - 590mm
Angled	1200mm - 2750mm	
Dual Curved / Straight Corner Panel (12mm only)		
Rectangular	1800mm - 2750mm	490mm - 590mm
Angled	2000mm - 2750mm	



System 50 Screen
50mm thick



System 75 Screen
75mm thick

SYSTEM 50 CABLE MANAGEMENT

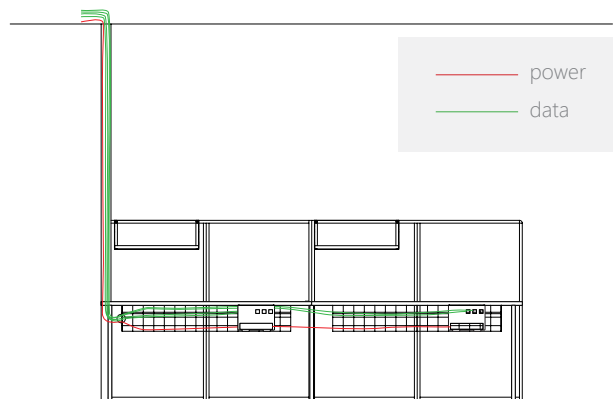

Power through Power blade, pole or umbilical to ceiling

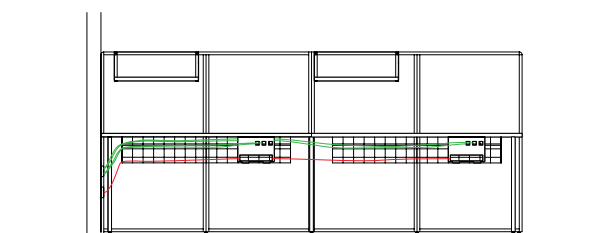

Power from wall mounted starter sockets to cable trays

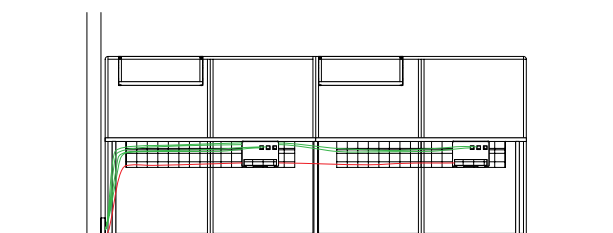

Power from duct mounted starter sockets to cable trays

SYSTEM 75 CABLE MANAGEMENT

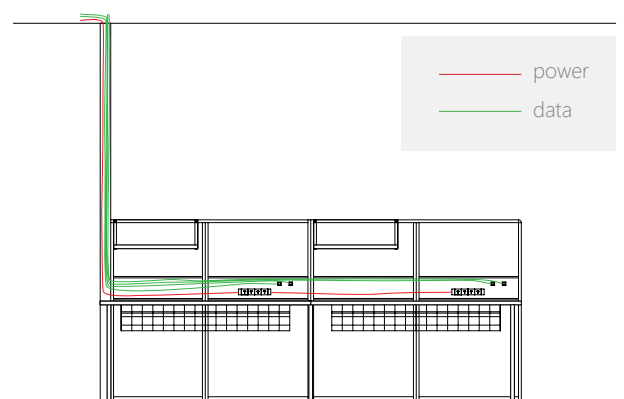

Power through Power blade, pole or umbilical to ceiling

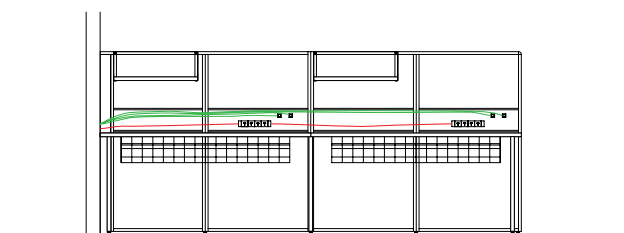

Power from wall through wall start into screen ducting

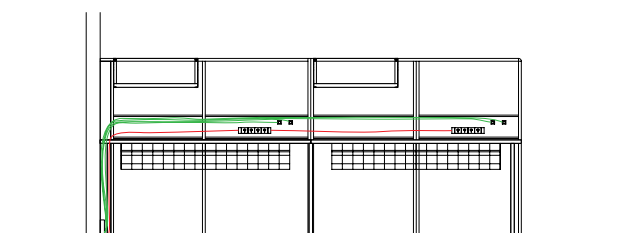

Power from ducted skirting through wall start into screen ducting

SYSTEM 50/75 SCREEN WITH VOLTARE LEG

Max. Height FFL1500.
Min. Height FFL900.

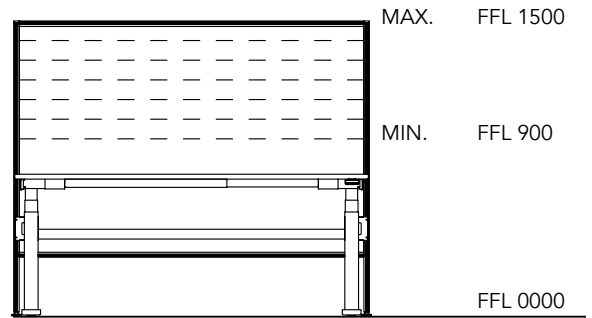
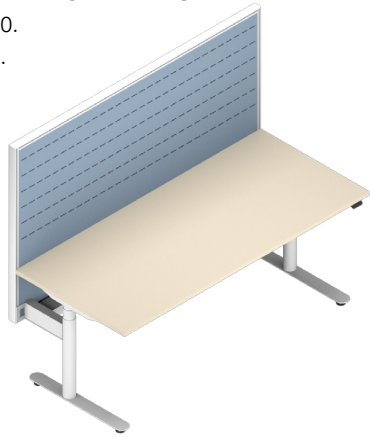

SYSTEM 50/75 SCREEN WITH H-FRAME LEG

Max. Height FFL1500.
Min. Height FFL900.

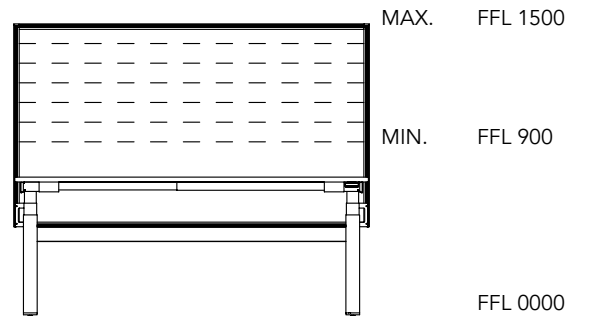
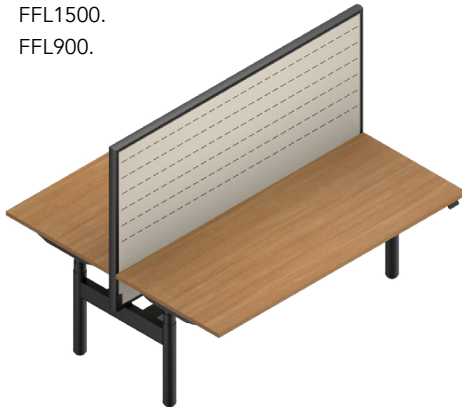

PANEL HUNG SHELF (HORIZONTAL ADJUSTMENT)

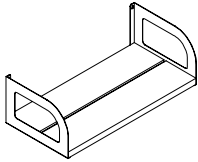

Panel Hung Shelf D-END
(Aluminium)

Standard Size
600W x 290D x 190H
900W x 290D x 190H

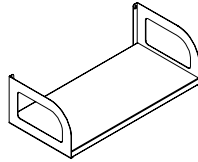

Panel Hung Shelf D-END
(Melamine)

Standard Size
600W x 290D x 190H
900W x 290D x 190H

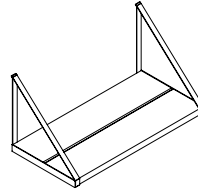

Panel Hung Shelf Wire-END
(Aluminium)

Standard Size
600W x 300D x 300H
900W x 300D x 300H

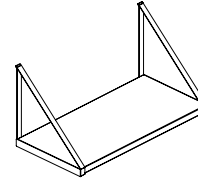

Panel Hung Shelf Wire-END
(Melamine)

Standard Size
600W x 300D x 300H
900W x 300D x 300H

PANEL HUNG SHELF (VERTICAL ADJUSTMENT)

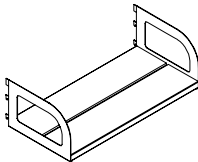

Panel Hung Shelf D-END
(Aluminium)

Standard Size
600W x 290D x 190H
900W x 290D x 190H

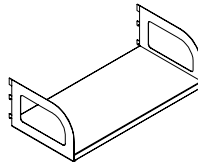

Panel Hung Shelf D-END
(Melamine)

Standard Size
600W x 290D x 190H
900W x 290D x 190H



Shelf Divider
(Aluminium)

Standard Size
270D x 175H

WALL HUNG SHELF

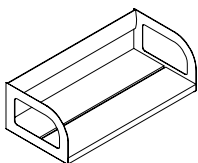

Panel Hung Shelf D-END
(Aluminium)

Standard Size
600W x 290D x 190H
900W x 290D x 190H

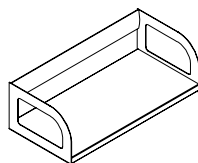

Panel Hung Shelf D-END
(Melamine)

Standard Size
600W x 290D x 190H
900W x 290D x 190H

CLAMP-ON ACCESSORIES

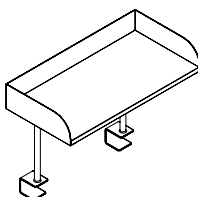

Clamp on Shelf

Standard Size
600W x 300D x 100H
325mm above benchtop

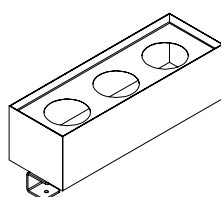

Clamp on Planter Box

Standard Size
600W x 200D x 175H
75mm above benchtop

ABOVE DESK POWER / DATA

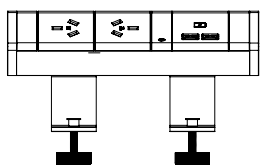

CMS Athena II

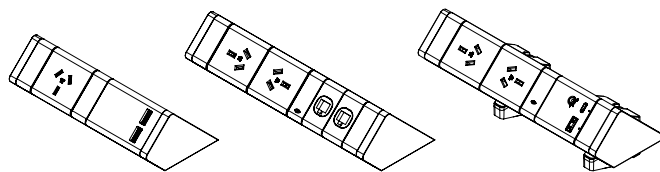
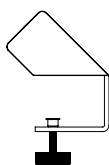

IN-DESK POWER / DATA

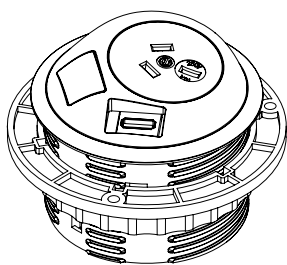

elsafe Pixel

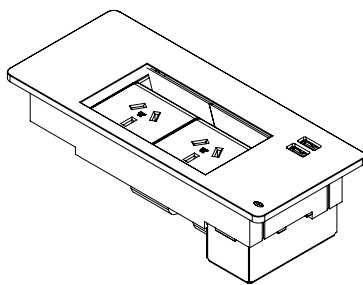

CMS Flip

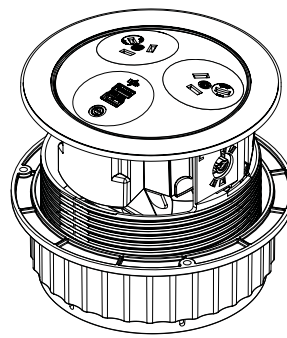

elsafe Pandora

IN-DESK SINGLE LID POWER BOX

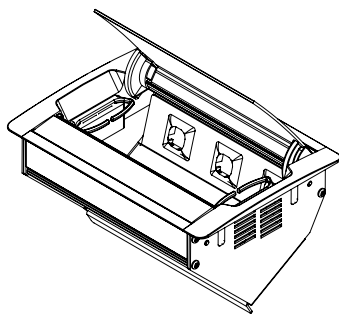

CMS Accede

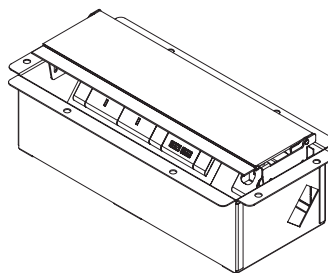

CMS Executive

WIRELESS CHARGING



ARC-80



ARC-H

MOBILE STORAGE UNITS (MELAMINE)

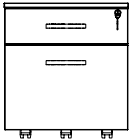

MD5
470W x 570D x 510H

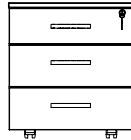

MD6
470W x 570D x 510H

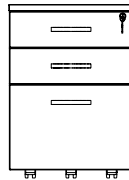

MD7
470W x 570D x 650H

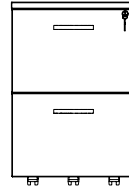

MD8
470W x 570D x 690H

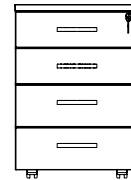

MD9
470W x 570D x 650H

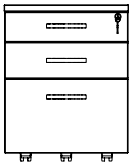

MD10
470W x 570D x 600H

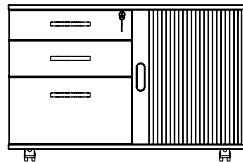

MCT3
900W x 570D x 600H

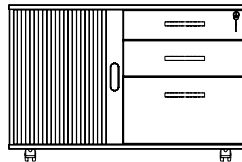

MCT4
900W x 570D x 600H

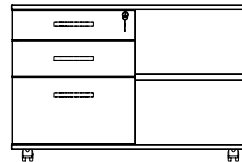

MC1
900W x 570D x 600H

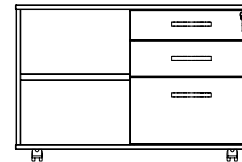

MC2
900W x 570D x 600H

MOBILE STORAGE UNITS (METAL)

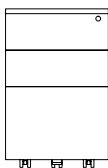

MM1
390W x 520D x 600H

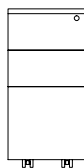

MN1
300W x 520D x 600H

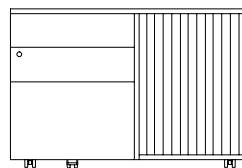

MMC1
900W x 500D x 610H

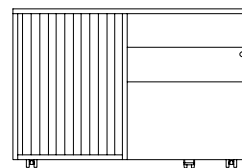

MMC2
900W x 500D x 610H

CPU HOLDER (CPU60)

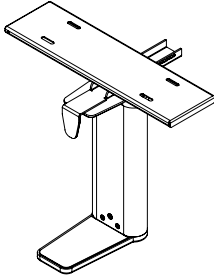

SPECIFICATIONS

Max. weight capacity:	10kg
Min. CPU size:	270mm x 75mm
Max. CPU size:	370mm x 200mm
Colour options:	White, Silver & White

CPU HOLDER (THIN CLIENT)

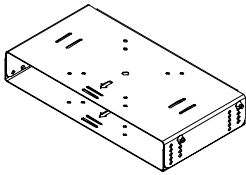

SPECIFICATIONS

Max. weight capacity:	12kg
Thickness range:	38mm - 67mm
Min. width:	274mm
Max. height:	255mm
Colour options:	Black

CPU HOLDER (LOOP)



SPECIFICATIONS

Max. weight capacity:	20kg
Min. CPU size:	275mm x 90mm
Max. CPU size:	550mm x 225mm
Colour options:	Black

UMBILICAL (CMS CIRQLATE)



SPECIFICATIONS

Cirqlate size:	72 x 15mm
Standard length:	770 / 2100 / 2800mm
Standard colour options:	Black, Silver, Clear, White
Special colour options: (Min. quantities apply)	Aqua, Light Green, Dark Green, Dark Blue, Light Blue, Orange, Pink, Yellow and Dark Red

CABLE BASKETS

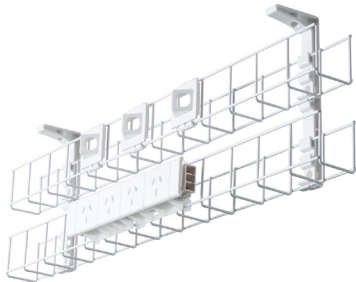

SPECIFICATIONS

Single tier, 100mm wide:	650 / 950 / 1250 / 1550 / 1750 / 2050mm
Dual tier, 100mm wide:	650 / 950 / 1250 / 1550 / 1750 / 2050mm

MONITOR ARMS (FLO)

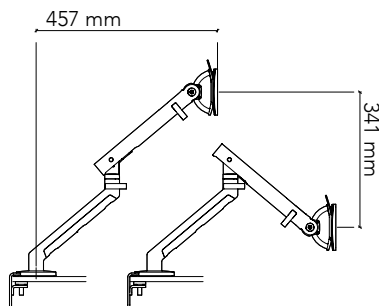

SPECIFICATIONS

Monitor weight range:	Max. 9kg per arm
Tilt range:	48.5° upwards, 48.5° downwards
Horizontal range:	570mm for desk clamp versions
Vertical range:	341mm
Colour:	silver, white and black
Monitor head:	VESA 75 & 100 compliant
Fixing options:	1. Split clamp 2. Dual split clamp 3. Through desk kit

MONITOR ARMS (C.ME)

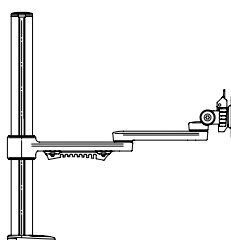

SPECIFICATIONS

Monitor weight range:	Max. 8kg per arm
Post height (standard):	430mm
Adjustment range:	330mm
Post height (long):	740mm
Adjustment range:	695mm
Horizontal range:	445mm
Colour:	white, polished and black
Monitor head:	VESA compliant

Finishes - Boards - Group 1 (Laminex).

Please refer to a physical sample.
Colours are for an indicative reference only.
Actual colour and finish may vary slightly.

Solids

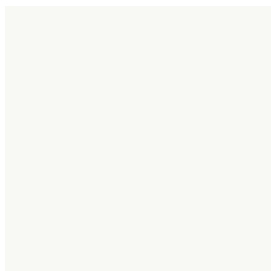

Polar White

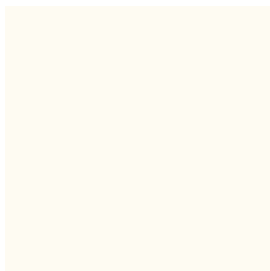

White

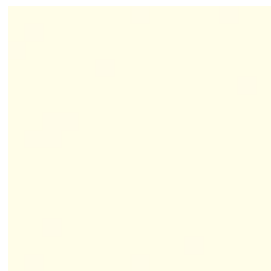

Parchment



Oyster Grey



Fox



Tornado



Fossil

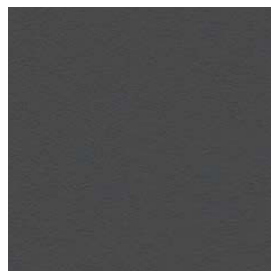

Battalion



Charcoal

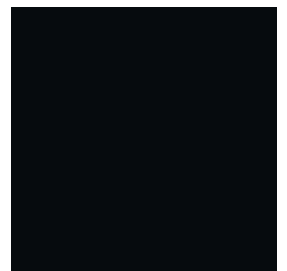

Black

Patterns



Zincworks



New Graphite

Finishes - Boards - Group 1 (Laminex).

Please refer to a physical sample.
Colours are for an indicative reference only.
Actual colour and finish may vary slightly.

Woodgrains



Dansk Maple



Milkwood



Seasoned Oak



Raw Birchply



Curly Birch



Young Beech



Select Beech



Elegant Oak



Sublime Teak



Classic Oak



Rural Oak



Alaskan



Oyster Linea



Fox Teakwood



Lustrous Elm



Natural Walnut

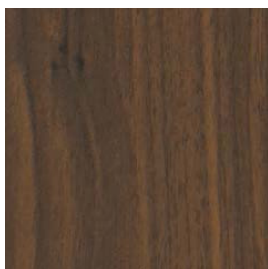

Milano Walnut



Jarraah Legno

Finishes - Boards - Group 1 (Polytec).

Please refer to a physical sample.
Colours are for an indicative reference only.
Actual colour and finish may vary slightly.

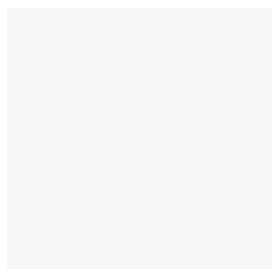

Polar White (Matt)

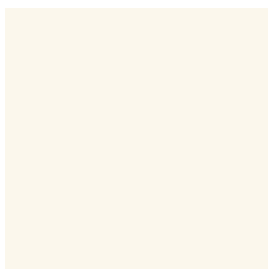

Natural White (Matt)

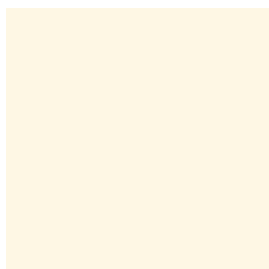

Parchment (Matt)



Marni Lini (Matt)



Soft Walnut (Matt)



Maison Oak (Matt)



Natural Oak (Matt)

Finishes - Boards - Veneer Range.

Please refer to a physical sample.
Colours are for an indicative reference only.
Actual colour and finish may vary slightly.



Figured Sycamore
(Quarter-cut)

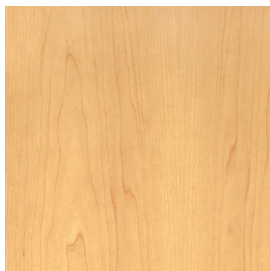

Rock Maple
(Crown-cut)

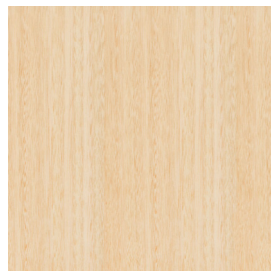

Victorian Ash
(Quarter-cut)



American Cherry
(Crown-cut)



European Beech
(Crown-cut)

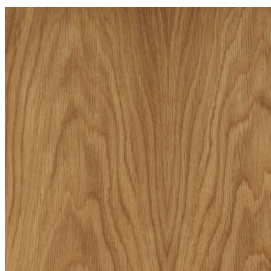

American White Oak
(Crown-cut)

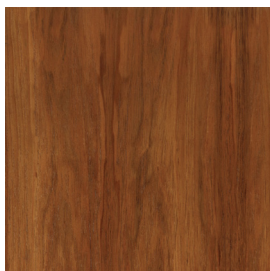

Tasmanian Blackwood
(Crown-cut)



Tasmanian Oak
(Quarter-cut)

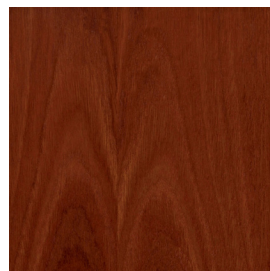

Jarrah (Crown-cut)

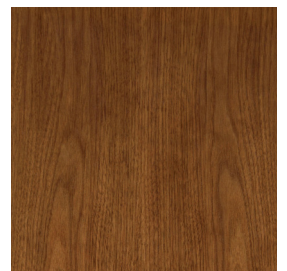

American Walnut
(Crown-cut)

Edge Profiles

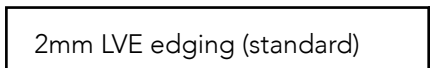

2mm LVE edging (standard)



Waterfall solid timber edging

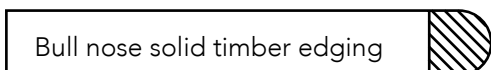

Bull nose solid timber edging

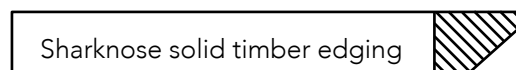

Sharknose solid timber edging

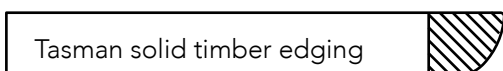

Tasman solid timber edging

Other edge profiles also available.
Please contact us for further information.

Screen Fabric.

Please refer to a physical sample.
Colours are for an indicative reference only.
Actual colour and finish may vary slightly.

Suzette



Limone



Splice



Pistachio



Mint

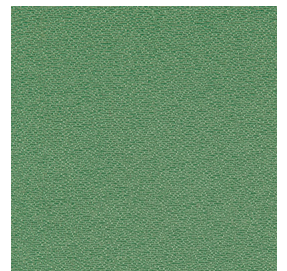

Celery

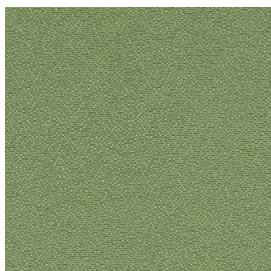

Decor



Citrus



Opal



Lucerne

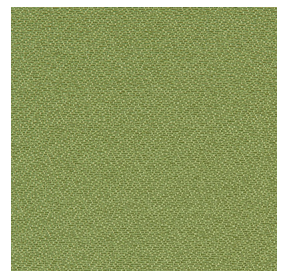

Hula

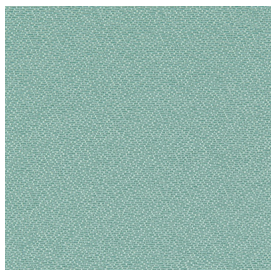

Humbug

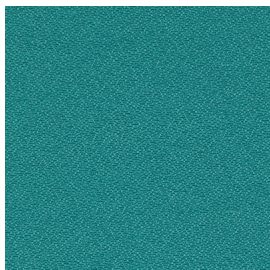

Joker

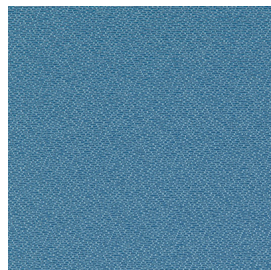

Mainsail

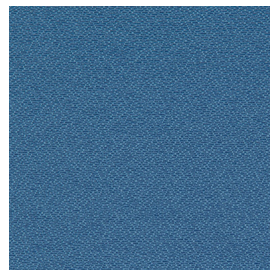

Luxury

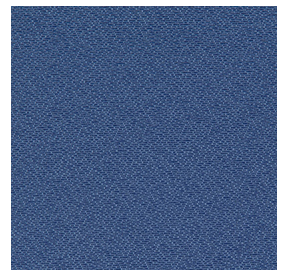

Olympia

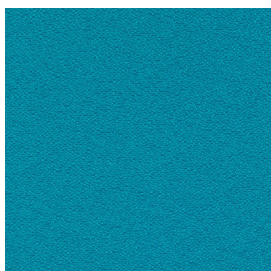

Cyan

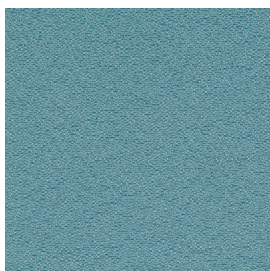

Tiffany

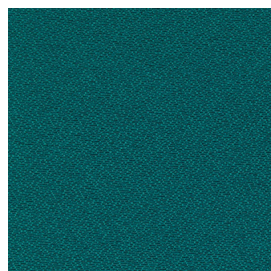

Aero



Iris

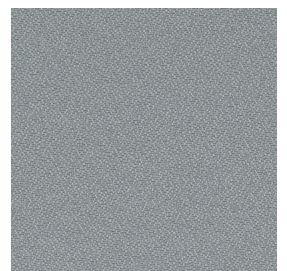

Dolphin

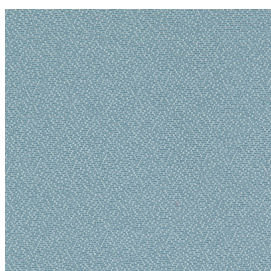

Twist

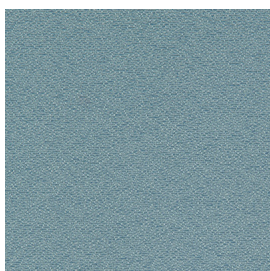

Heaven

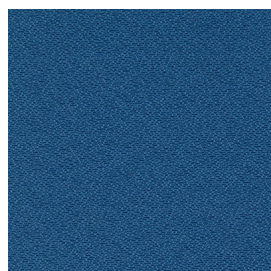

Conquest

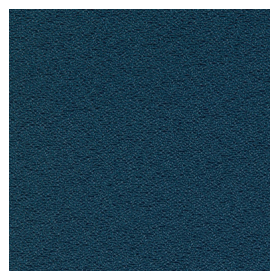

Octane

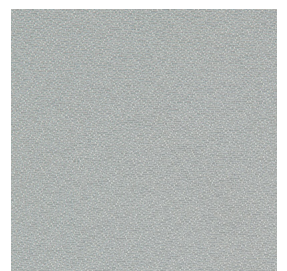

Blizzard

Screen Fabric.

Please refer to a physical sample.
Colours are for an indicative reference only.
Actual colour and finish may vary slightly.

Suzette



Tequila

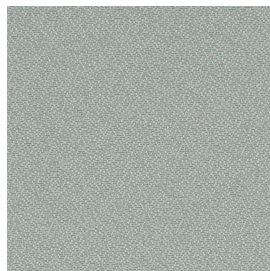

Pavement

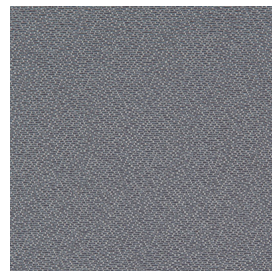

Spire



Periwinkle

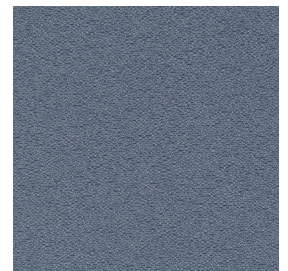

Nimble



Shadow



Sinker



Stormcloud

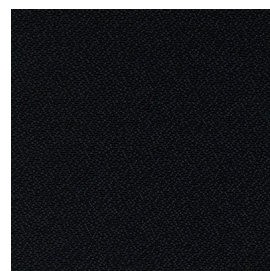

Stallion



Popeye



Mulberry

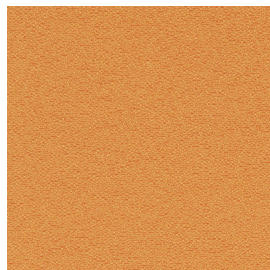

Pizzazz

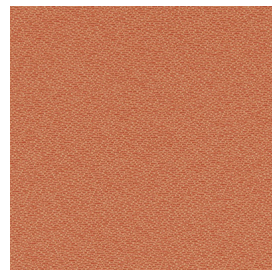

Vibrant

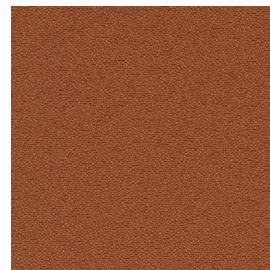

Russet

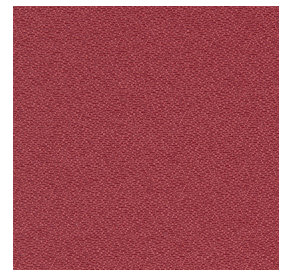

Gala

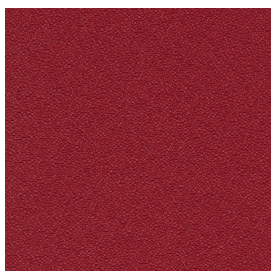

Rosso



Organic



White

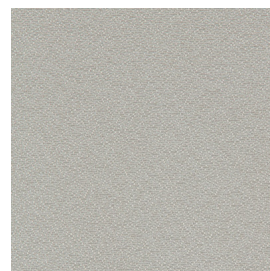

Eggshell



Ivory

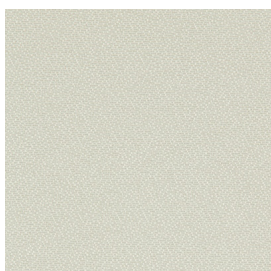

Ice cream



Neutral



Cafe

Screen Fabric.

Please refer to a physical sample.
Colours are for an indicative reference only.
Actual colour and finish may vary slightly.

Trilogy I

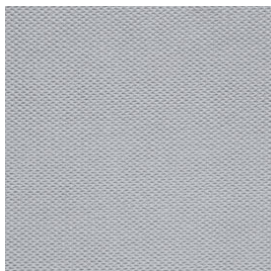

Glacier

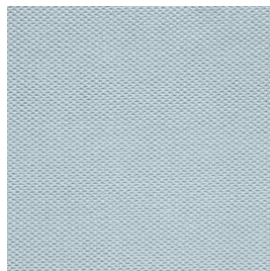

Polar

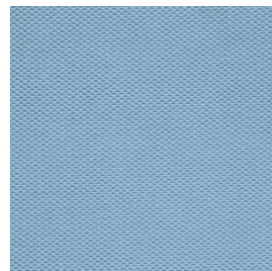

Icecap

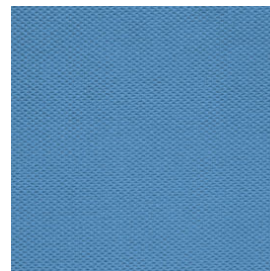

Bluebell

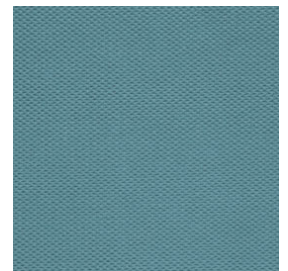

Jade

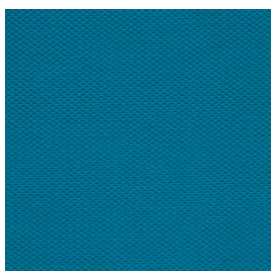

Teal

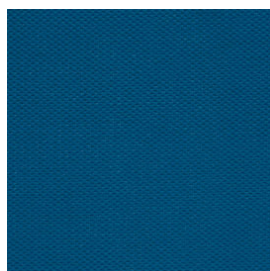

Ink



Cobalt

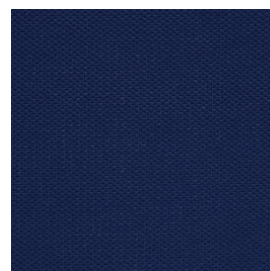

Indigo

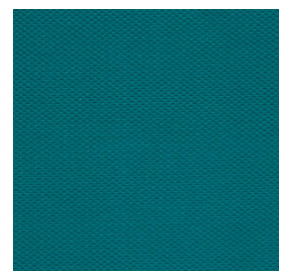

Emerald

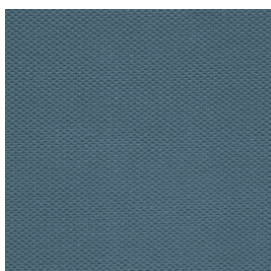

Hydra

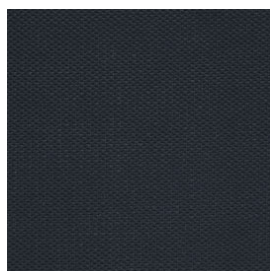

Oxide

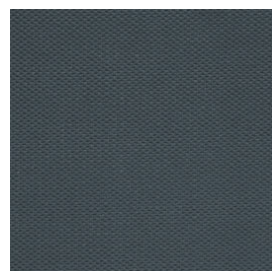

Smoke

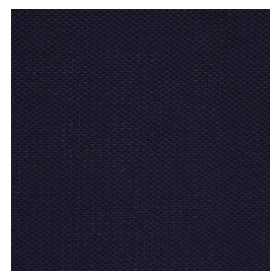

Midnight

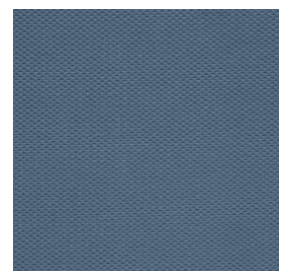

Ocean

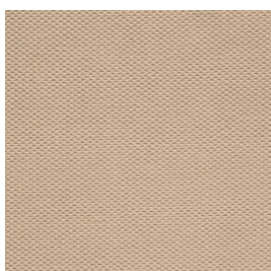

Stone

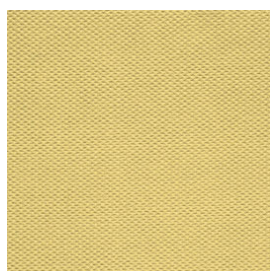

Banana

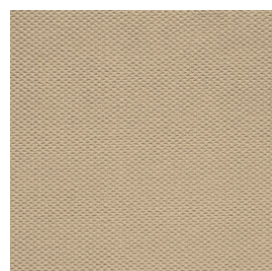

Putty

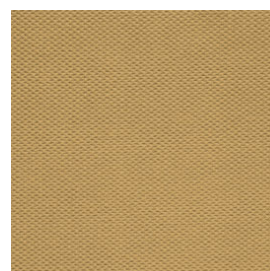

Barley

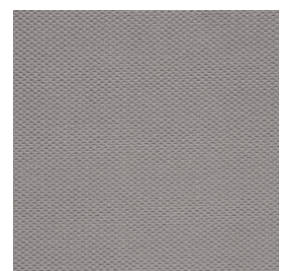

Chrome

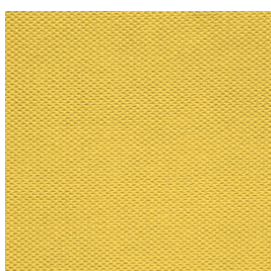

Daffodil

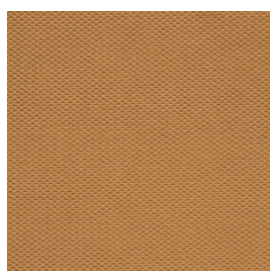

Gold

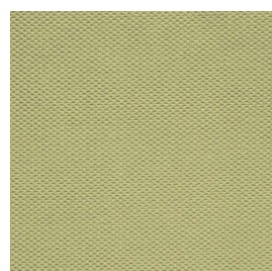

Lime

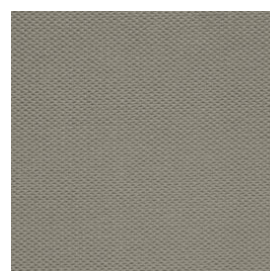

Sage

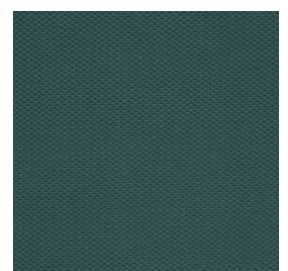

Forest

Screen Fabric.

Please refer to a physical sample.
Colours are for an indicative reference only.
Actual colour and finish may vary slightly.

Trilogy I

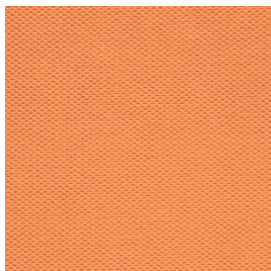

Paw Paw

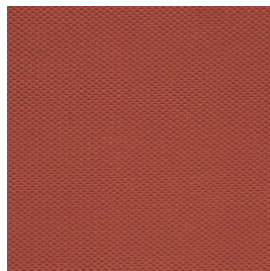

Sienna

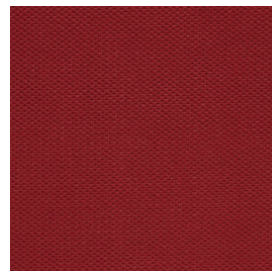

Flame

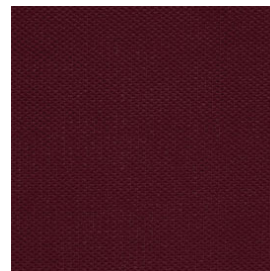

Wine

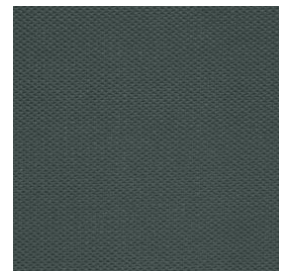

Loden

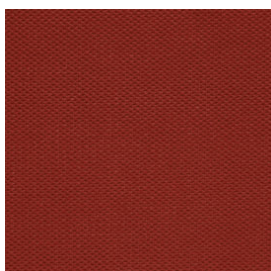

Henna



Cherry

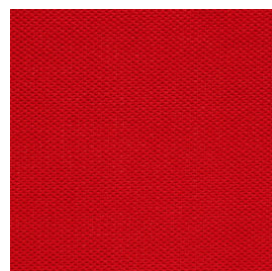

Tangerine

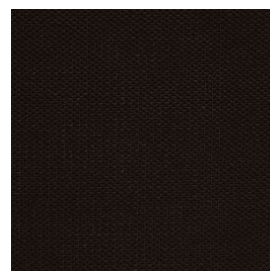

Chocolate

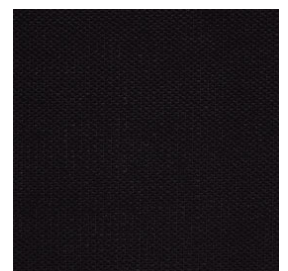

Black

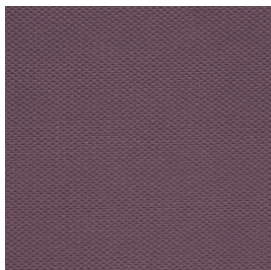

Lavender



Aubergine

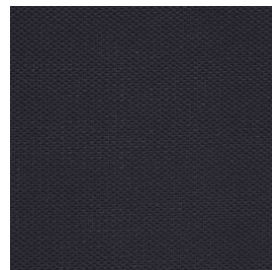

Charcoal

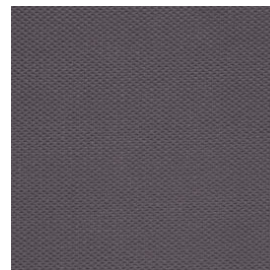

Battleship

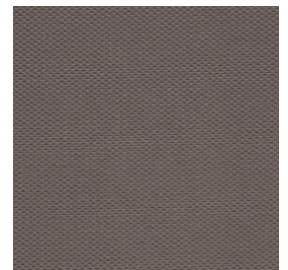

Dove

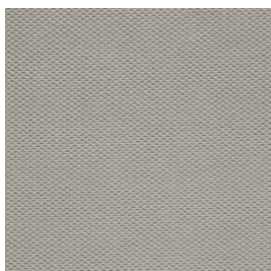

Dust

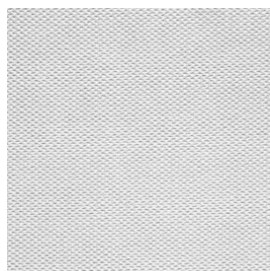

Misty

Finishes - Ecooustic.

Please refer to a physical sample.
Colours are for an indicative reference only.
Actual colour and finish may vary slightly.

12mm Thick

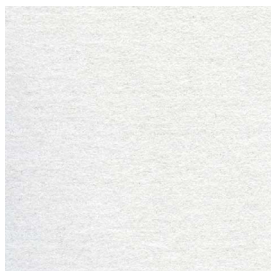

Snowdrop

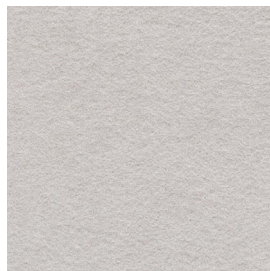

Horizon

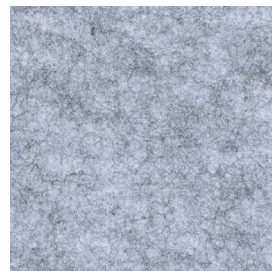

Oxide



Cool

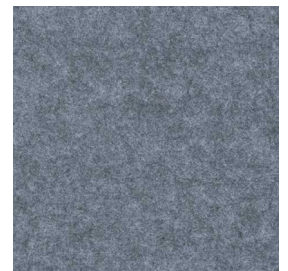

Tungsten

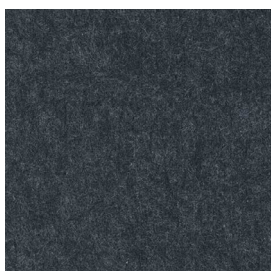

Galaxy



Almond



Fawn



Arizona



Venus



Olive



Leaf



Bluebell



Denim



Iris

24mm Thick



Pure



Stone

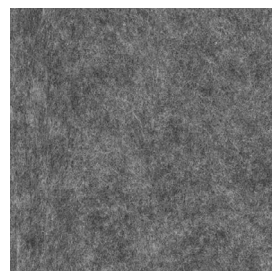

Ash

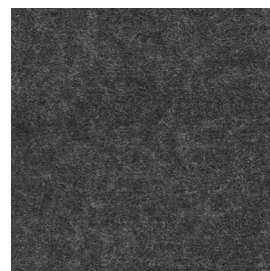

Graphite

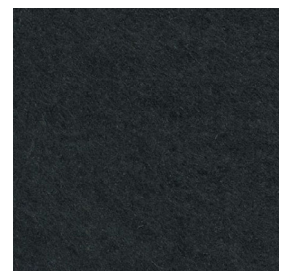

Nero

Powder Coat Range.

Please refer to a physical sample.
Colours are for an indicative reference only.
Actual colour and finish may vary slightly.

Standard

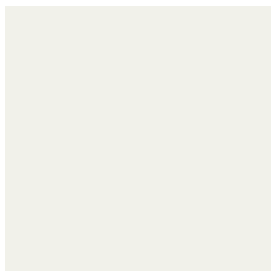

Satin White

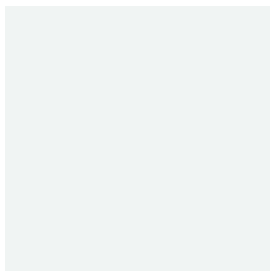

Pearl White

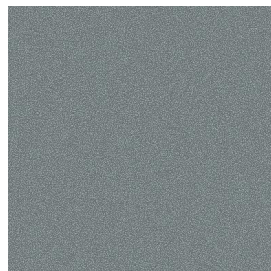

Precious Silver Pearl

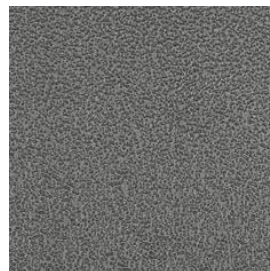

Graphite Ripple

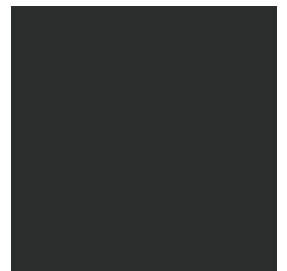

Black

Extended

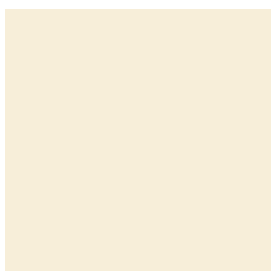

White Birch

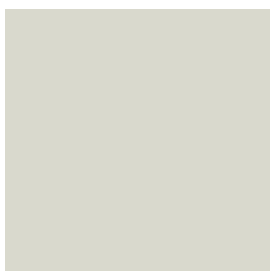

Off White



Stromboli



Deep Ocean

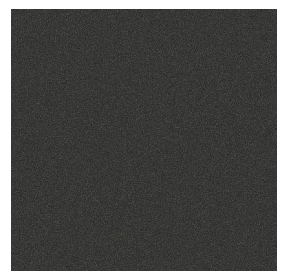

Gunmetal Kinetic Pearl



Lemon Yellow



Orange X15



Signal Red



Blaze Blue

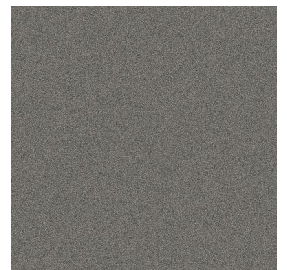

Champagne Kinetic Pearl



Stone Grey



Wedgewood



Monument

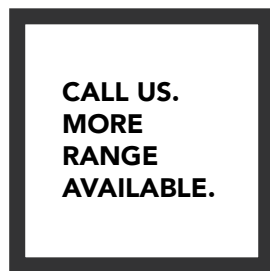



Watts Commercial Furniture
350a Edgar St
Bankstown NSW 2200

p: 02 9771 3966
f: 02 9771 6824

sales.watts@wcf.com.au
accounts.watts@wcf.com.au

www.wcf.com.au

Watts Commercial Furniture reserves the right to change any or all details without prior notice. Every effort has been made to ensure the information is accurate at the time of printing.

November 2020