



ALTURA FRAME
workstations

Contents.

ALTURA WORKSTATION.

| | |
|--|-----------|
| Specifications - Overview | p.3 |
| Specifications - Frame / Top | p.4 |
| Options - Excess Cable / Cut-Out | p.5 - 6 |
| Typical Layout | p.7 - 11 |
| Options - Feature Rail / Screen | p.12 - 13 |
| Options - System 50 / 75 Screen | p.14 - 15 |
| Options - System 50 / 75 Accessories | p.16 |
| Options - Mobile Storage | p.17 |
| Options - Power / Data | p.18 |
| Options - Cable Management / Monitor Arm | p.19 |
| Options - CPU Holder | p.20 |

FINISHES.

| | |
|-----------------------------------|-----------|
| Boards - Laminex Commercial Range | p.21 - 23 |
| Boards - Polytec Ravine Range | p.24 |
| Boards - Timber Veneer Range | p.25 |
| Screen - Fabric - Suzette | p.26 - 28 |
| Screen - PET - Autex Cube | p.29 |

WATTS COMMERCIAL FURNITURE POLICIES.

| | |
|----------------------|------|
| Environmental Policy | p.30 |
| Quality Policy | p.31 |



**HEIGHT ADJUSTABLE
SIT-STAND
WORKSTATIONS**

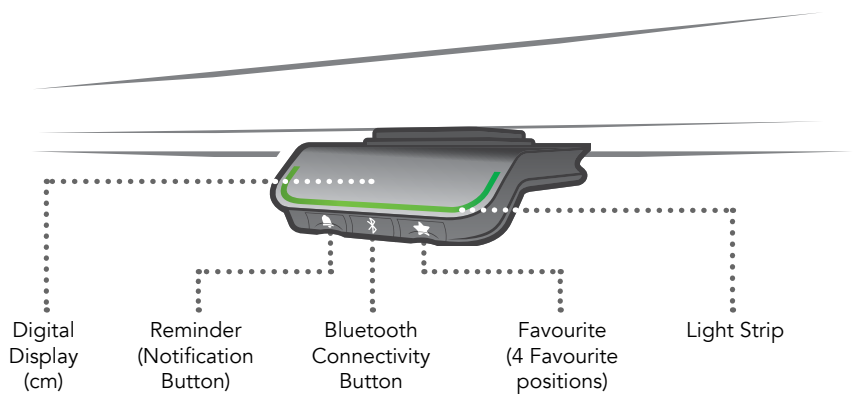

Desk Control™ apps

The ALTURA FRAME workstation has in-built bluetooth connectivity. With Desk Control apps, you can connect your Altura Frame workstation with your iOS and Android devices to control height adjustment and activate pre-set height configurations.

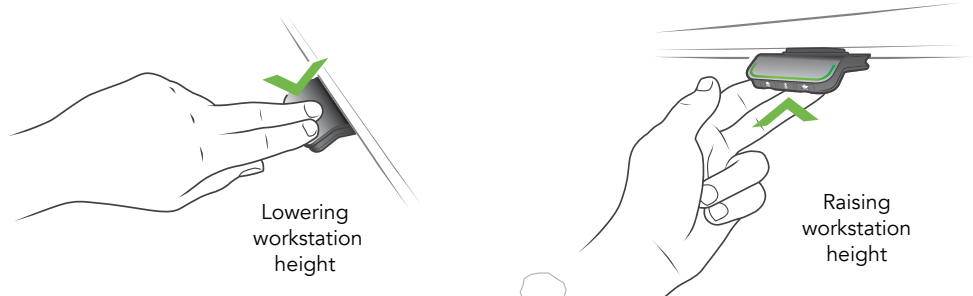

Max. Height 1260mm

Min. Height 610mm

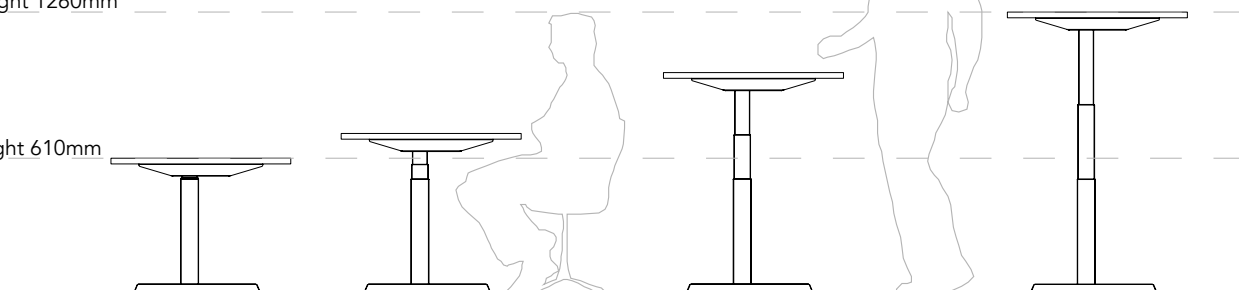

Specifications.

Please refer to a physical sample.
 Images are for an indicative reference only.
 Actual product may vary slightly, depending upon model configurations.

GENERAL SPECIFICATIONS

| | |
|----------------------------------|-----------------------------------|
| Standard rectangular desk width: | 1200mm - 2100mm |
| Standard rectangular desk depth: | 600mm - 900mm |
| Standard corner desk size range: | 1500mm x 1500mm - 2100mm x 2100mm |
| Height adjustment range: | 610mm - 1260mm |
| Weight capacity per leg: | 80kg |
| Frame Colour: | White / Silver / Black |

NOTES:

Other colours available upon request.
 MOQ apply

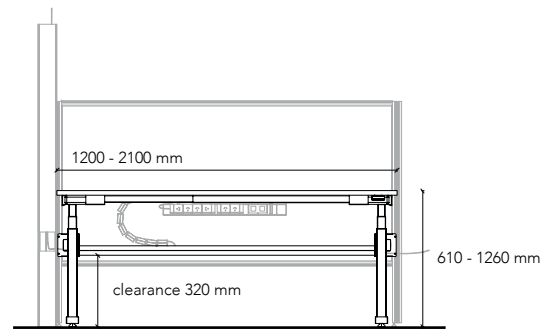
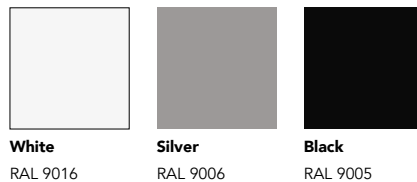

STANDARD TABLE TOPS

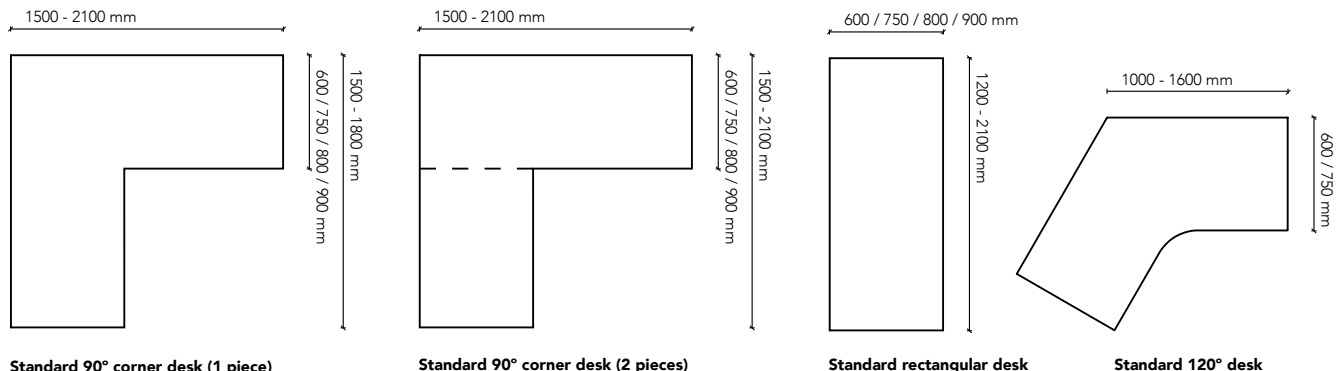
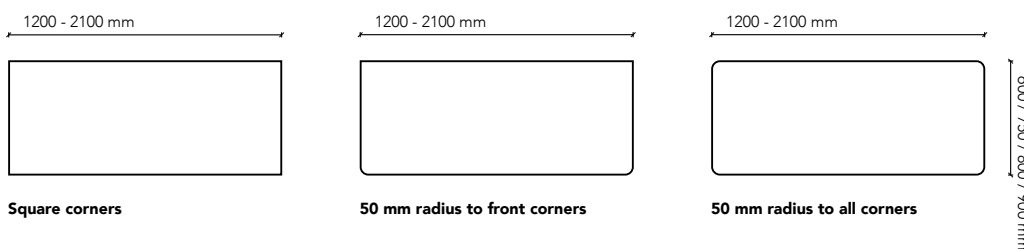

TABLE TOPS CORNER FINISH OPTIONS

Standard table tops can be specified 25 mm or 33 mm thick with square or rounded corners (50mm / 100mm radius).



Watts Commercial Furniture

350a Edgar St
 Bankstown NSW 2200
 PO Box 275 Condell Park 2200
 ABN: 54 064 557 893

p: 02 9771 3966
 wcf.com.au
 sales.watts@wcf.com.au
 accounts.watts@wcf.com.au

Watts Commercial Furniture reserves the right to change any or all details without prior notice. Every effort has been made to ensure the information is accurate at the time of printing.

August 2023

Specifications.

Please refer to a physical sample.
 Images are for an indicative reference only.
 Actual product may vary slightly, depending upon model configurations.

FOOT STYLES

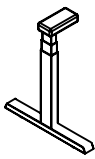

Centre foot 600/800 mm

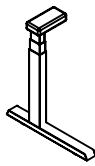

Rear foot 600/800 mm

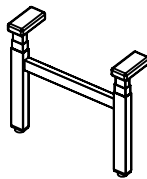

H-Frame Leg

TABLE TOP EDGE OPTIONS

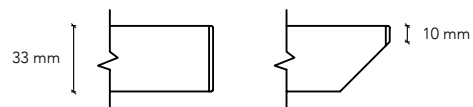
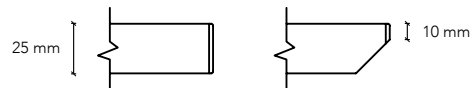

Standard

Sharknose

EXCESS CABLES - CUTOUT

Excess cables can be taken off the desk with a cutout, a cable port or a cable brush. Must be specified with the worksurface

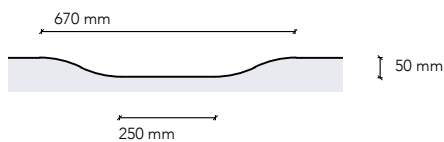

Large Scallop

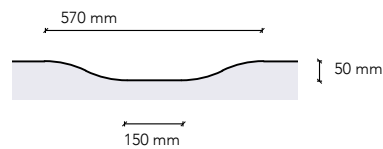

Small Scallop

EXCESS CABLES - CABLE BRUSH / CABLE FLAPS

Excess cables can be taken off the desk with a cutout, a cable port or a cable brush. Must be specified with the worksurface



Standard Cable Brush
 Must be specified with the worksurface

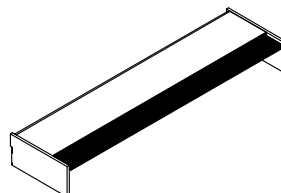

Standard Cable Flaps
 Must be specified with the worksurface

Watts Commercial Furniture

350a Edgar St
 Bankstown NSW 2200
 PO Box 275 Condell Park 2200
 ABN: 54 064 557 893

p: 02 9771 3966
 wcf.com.au
 sales.watts@wcf.com.au
 accounts.watts@wcf.com.au

Watts Commercial Furniture reserves the right to change any or all details without prior notice. Every effort has been made to ensure the information is accurate at the time of printing.

August 2023

Specifications.

Please refer to a physical sample.
 Images are for an indicative reference only.
 Actual product may vary slightly, depending upon model configurations.

EXCESS CABLES - STANDARD 60MM / 80MM CABLE PORT

Excess cables can be taken off the desk with a cutout, a cable port or a cable brush. Must be specified with the worksurface

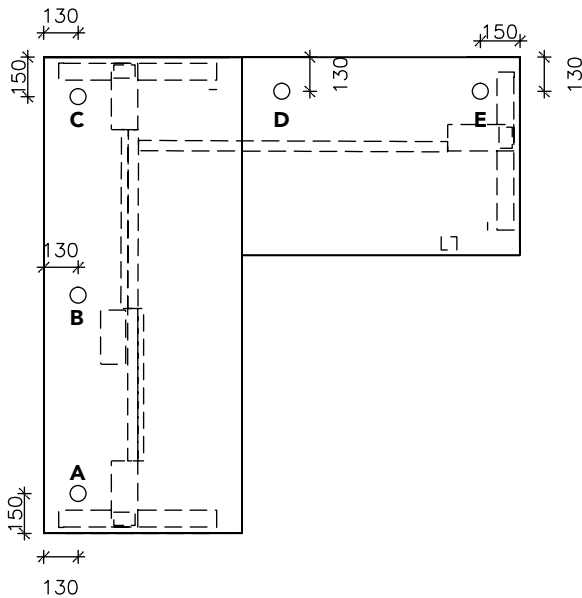
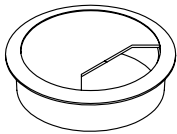

90° Corner Desk
 Standard Cable Port Location

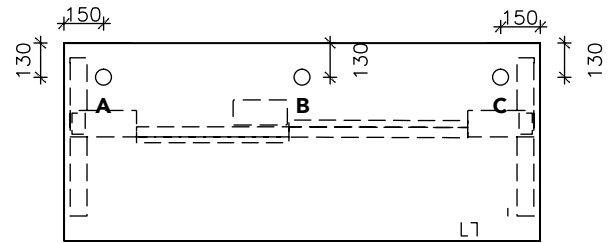

Rectangular Desk
 Standard Cable Port Location

Watts Commercial Furniture

350a Edgar St
 Bankstown NSW 2200
 PO Box 275 Condell Park 2200
 ABN: 54 064 557 893

p: 02 9771 3966
 wcf.com.au
 sales.watts@wcf.com.au
 accounts.watts@wcf.com.au

Watts Commercial Furniture reserves the right to change any or all details without prior notice. Every effort has been made to ensure the information is accurate at the time of printing.

August 2023

Freestanding Workstation Layouts.

Please refer to a physical sample.
Images are for an indicative reference only.
Actual product may vary slightly, depending upon model configurations.

RECTANGULAR DESK

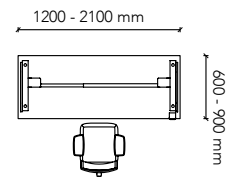
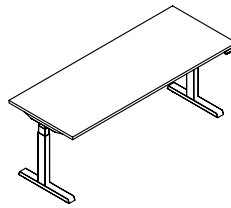

RECTANGULAR DESK 2 WAY BACK TO BACK LAYOUT

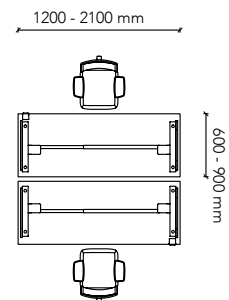
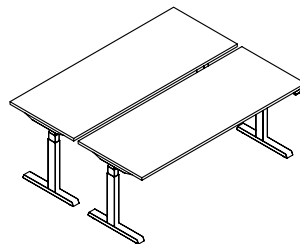

RECTANGULAR DESK 2 WAY SIDE BY SIDE

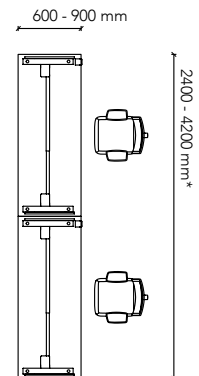
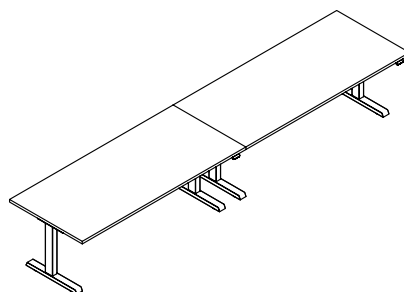

Watts Commercial Furniture

350a Edgar St
Bankstown NSW 2200
PO Box 275 Condell Park 2200
ABN: 54 064 557 893

p: 02 9771 3966
wcf.com.au
sales.watts@wcf.com.au
accounts.watts@wcf.com.au

Watts Commercial Furniture reserves the right to change any or all details without prior notice. Every effort has been made to ensure the information is accurate at the time of printing.

August 2023

Freestanding Workstation Layouts.

Please refer to a physical sample.
 Images are for an indicative reference only.
 Actual product may vary slightly, depending upon model configurations.

RECTANGULAR DESK 4 WAY

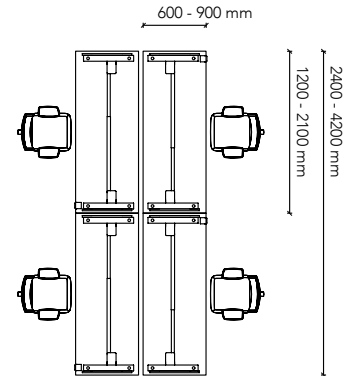
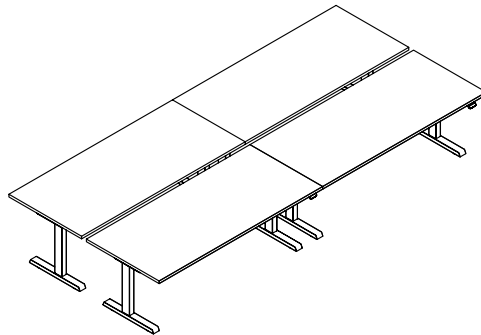

90° CORNER DESK

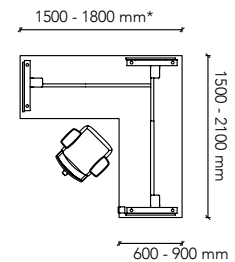
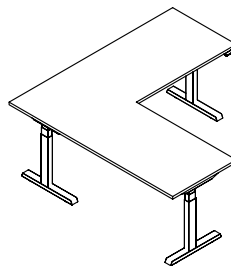

NOTE

* worktop can be extended with additional piece.

90° 2-WAY WORKSTATION

T LAYOUT

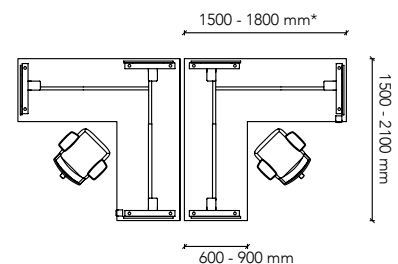
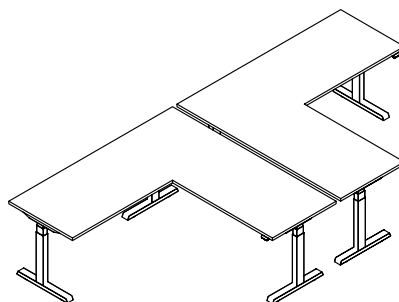

NOTE

* worktop can be extended with additional piece.

Watts Commercial Furniture

350a Edgar St
 Bankstown NSW 2200
 PO Box 275 Condell Park 2200
 ABN: 54 064 557 893

p: 02 9771 3966
wcf.com.au
sales.watts@wcf.com.au
accounts.watts@wcf.com.au

Watts Commercial Furniture reserves the right to change any or all details without prior notice. Every effort has been made to ensure the information is accurate at the time of printing.

August 2023

Freestanding Workstation Layouts.

Please refer to a physical sample.
 Images are for an indicative reference only.
 Actual product may vary slightly, depending upon model configurations.

90° 2-WAY WORKSTATION U LAYOUT

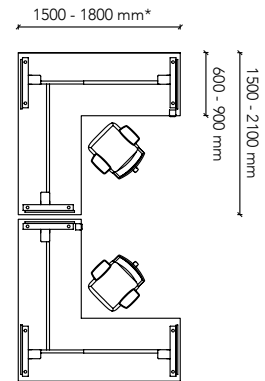
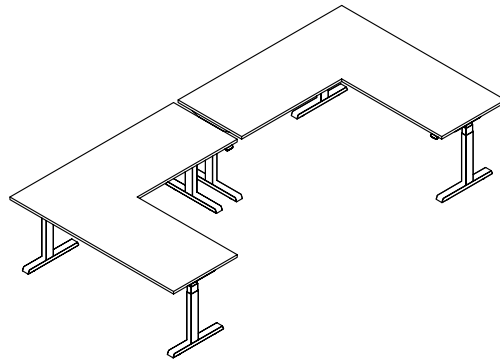

NOTE

* worktop can be extended with additional piece.

90° 4-WAY WORKSTATION CROSS LAYOUT

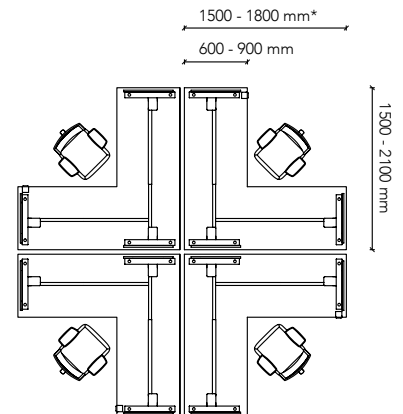
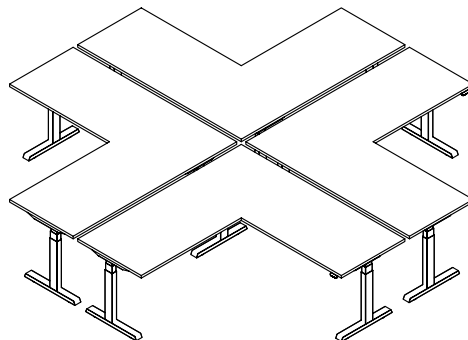

NOTE

* worktop can be extended with additional piece.

120° 3 WAY WORKSTATION

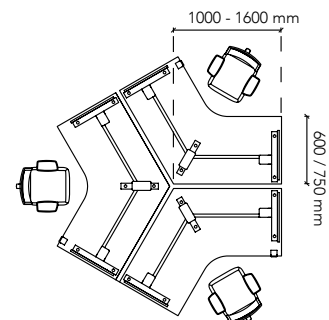
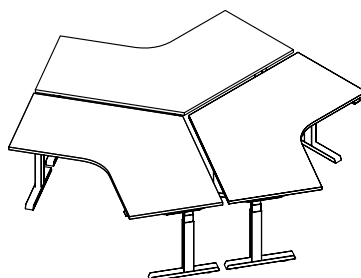

Watts Commercial Furniture

350a Edgar St
 Bankstown NSW 2200
 PO Box 275 Condell Park 2200
 ABN: 54 064 557 893

p: 02 9771 3966
 wcf.com.au
 sales.watts@wcf.com.au
 accounts.watts@wcf.com.au

Watts Commercial Furniture reserves the right to change any or all details without prior notice. Every effort has been made to ensure the information is accurate at the time of printing.

August 2023

H-Frame Workstation Layouts.

Please refer to a physical sample.
Images are for an indicative reference only.
Actual product may vary slightly, depending upon model configurations.

RECTANGULAR DESK 2 WAY

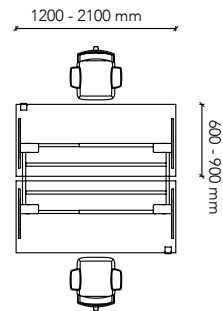
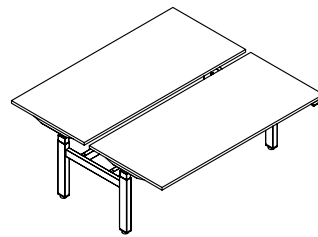

RECTANGULAR DESK 4 WAY

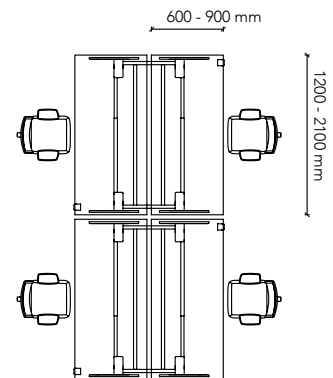
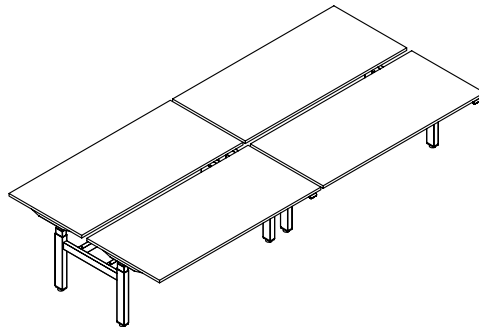

90° 2-WAY WORKSTATION T LAYOUT

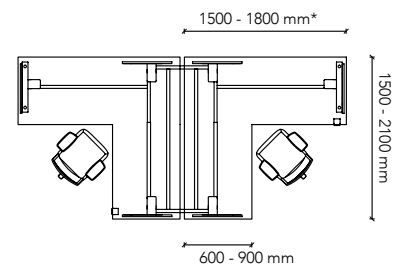
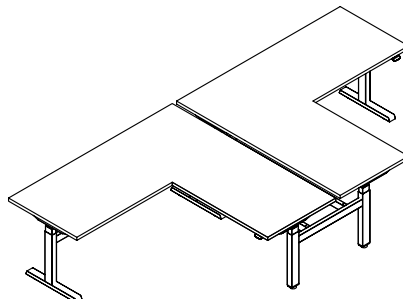

NOTE

* worktop can be extended with additional piece.

Watts Commercial Furniture

350a Edgar St
Bankstown NSW 2200
PO Box 275 Condell Park 2200
ABN: 54 064 557 893

P • 10 | wcf.com.au

p: 02 9771 3966
wcf.com.au
sales.watts@wcf.com.au
accounts.watts@wcf.com.au

Watts Commercial Furniture reserves the right to change any or all details without prior notice. Every effort has been made to ensure the information is accurate at the time of printing.

August 2023

H-Frame Workstation Layouts.

Please refer to a physical sample.
 Images are for an indicative reference only.
 Actual product may vary slightly, depending upon model configurations.

90° 4-WAY WORKSTATION CROSS LAYOUT

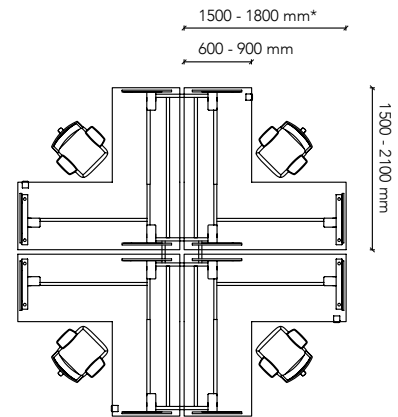
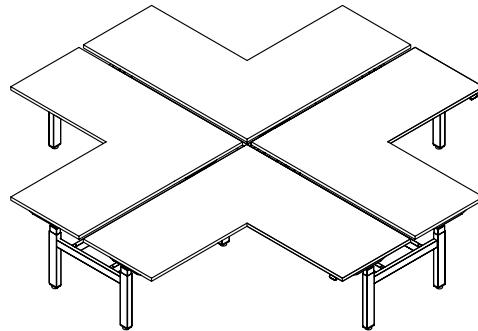

NOTE

* worktop can be extended with additional piece.

120° 3 WAY WORKSTATION

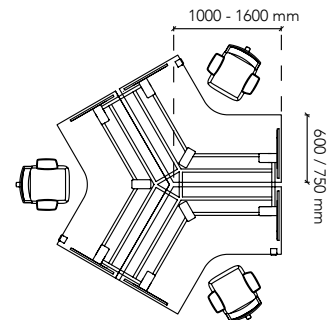
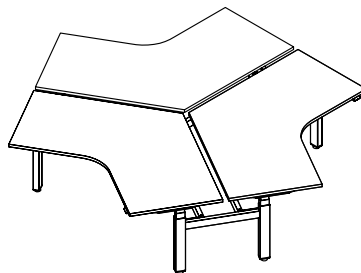

*** OTHER SIZES / CONFIGURATIONS AVAILABLE. CALL 02 9771 3966 FOR FURTHER INFORMATION.
 DEFAULT FRAME COLOUR : WHITE / SILVER / BLACK**

Watts Commercial Furniture

350a Edgar St
 Bankstown NSW 2200
 PO Box 275 Condell Park 2200
 ABN: 54 064 557 893

p: 02 9771 3966
 wcf.com.au
 sales.watts@wcf.com.au
 accounts.watts@wcf.com.au

Watts Commercial Furniture reserves the right to change any or all details without prior notice. Every effort has been made to ensure the information is accurate at the time of printing.

August 2023

Altura Workstation - Options.

Please refer to a physical sample.
 Images are for an indicative reference only.
 Actual product may vary slightly, depending upon model configurations.

FEATURE RAIL

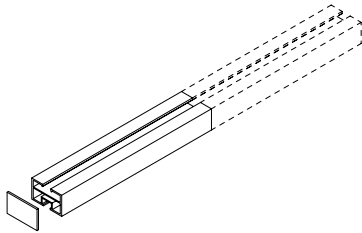

SPECIFICATIONS

| | |
|--------------|---|
| Height: | 24.5mm |
| Width: | 40mm |
| Accessories: | Divider screen |
| Finishes | Brushed aluminium (Standard) Powder coated (Special request) |

DIVIDER SCREEN (FEATURE RAIL MOUNT)



SPECIFICATIONS

| | |
|-------------------|--|
| Standard width: | 600 / 900 / 1200mm |
| Standard height: | 300 / 400 / 500mm |
| Material options: | <ol style="list-style-type: none"> Perspex Panel (10mm) PET Panel (12mm / 24mm) Laminate Panel (18mm / 25mm) Fabric Panel (16mm / 35mm) Perforated Plywood Panel (12mm) |

ENVY SCREEN (DESK MOUNT)



Single Panel
Rectangular



Single Curved Return Panel
Rectangular



Dual Curved Return Panel
Rectangular



Single Straight Return Panel
Rectangular



Dual Straight Return Panel
Rectangular



Single Panel
Angled

SPECIFICATIONS

| | |
|-------------------|--|
| Material options: | <ol style="list-style-type: none"> PET Panel (12mm) PET Panel Dual Layer (24mm) Fabric Wrapped PET Panel (35mm) |
|-------------------|--|

| Single Panel | Standard Width | Standard Height |
|---|-----------------|-----------------|
| Rectangular | 600mm - 2750mm | 490mm - 590mm |
| Angled | 900mm - 2750mm | |
| Single Curved / Straight Return Panel (12mm only) | | |
| Rectangular | 1200mm - 2750mm | 490mm - 590mm |
| Angled | 1200mm - 2750mm | |
| Dual Curved / Straight Return Panel (12mm only) | | |
| Rectangular | 1800mm - 2750mm | 490mm - 590mm |
| Angled | 2000mm - 2750mm | |

Watts Commercial Furniture

350a Edgar St
 Bankstown NSW 2200
 PO Box 275 Condell Park 2200
 ABN: 54 064 557 893

p: 02 9771 3966
 wcf.com.au
 sales.watts@wcf.com.au
 accounts.watts@wcf.com.au

Watts Commercial Furniture reserves the right to change any or all details without prior notice. Every effort has been made to ensure the information is accurate at the time of printing.

August 2023

Altura Workstation - Options.

Please refer to a physical sample.
Images are for an indicative reference only.
Actual product may vary slightly, depending upon model configurations.

BANKSIA SCREEN (FIXED TO SYSTEM FRAME)

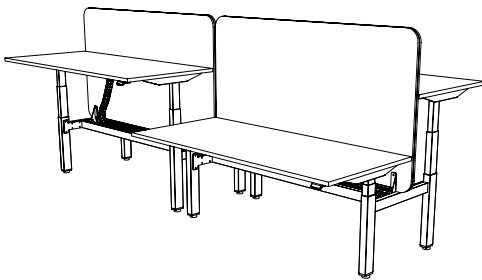

SPECIFICATIONS

| | |
|------------------|---|
| Standard width: | 1200 - 2100mm |
| Standard height: | 900 - 1500mm AFFL |
| Material: | Fabric Wrapped Screen (35mm) |
| Style options: | 1. Single tone 2. Two tone 3. Quilted upholstery detail |

DIVIDER SCREEN (SLIDE ON)

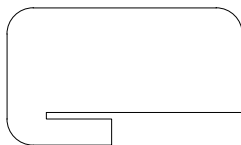

STRAIGHT
Fits desk thickness
25 / 33mm only

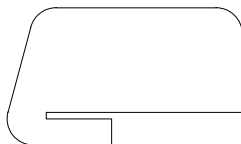

ANGLED
Fits desk thickness
25 / 33mm only

SPECIFICATIONS

| | |
|-------------------|--|
| Standard width: | 850W / 900W / 950W |
| Standard height: | 300H / 400H / 480H |
| Material options: | 1. PET Panel (24mm) 2. Melamine Panel (25mm / 32mm) 3. Fabric Panel (35mm) |

Watts Commercial Furniture

350a Edgar St
Bankstown NSW 2200
PO Box 275 Condell Park 2200
ABN: 54 064 557 893

p: 02 9771 3966
wcf.com.au
sales.watts@wcf.com.au
accounts.watts@wcf.com.au

Watts Commercial Furniture reserves the right to change any or all details without prior notice. Every effort has been made to ensure the information is accurate at the time of printing.

August 2023

Altura Workstation - Options.

Please refer to a physical sample.
 Images are for an indicative reference only.
 Actual product may vary slightly, depending upon model configurations.



System 50 Screen
50mm thick



System 75 Screen
75mm thick

SYSTEM 50 CABLE MANAGEMENT

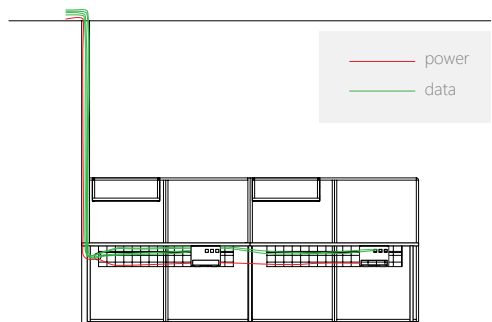

Power through Power blade, pole or umbilical to ceiling

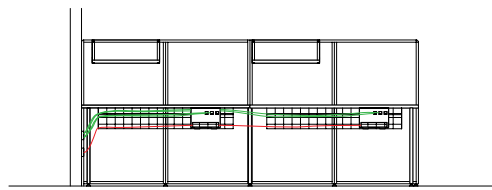

Power from wall mounted starter sockets to cable trays

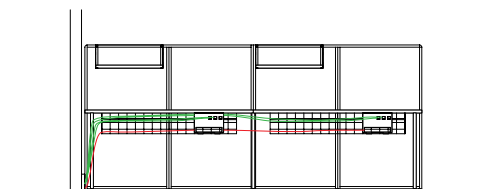

Power from duct mounted starter sockets to cable trays

SYSTEM 75 CABLE MANAGEMENT

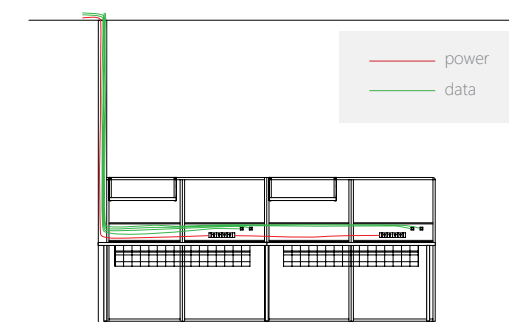

Power through Power blade, pole or umbilical to ceiling

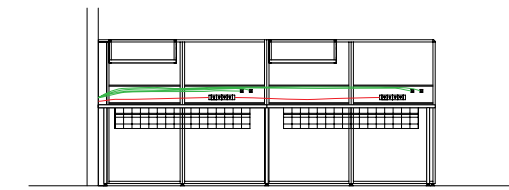

Power from wall through wall start into screen ducting



Power from ducted skirting through wall start into screen ducting

Watts Commercial Furniture

350a Edgar St
 Bankstown NSW 2200
 PO Box 275 Condell Park 2200
 ABN: 54 064 557 893

p: 02 9771 3966
 wcf.com.au
 sales.watts@wcf.com.au
 accounts.watts@wcf.com.au

Watts Commercial Furniture reserves the right to change any or all details without prior notice. Every effort has been made to ensure the information is accurate at the time of printing.

August 2023

Altura Workstation - Options.

Please refer to a physical sample.
 Images are for an indicative reference only.
 Actual product may vary slightly, depending upon model configurations.

SCREEN WITH ALтура LEG

Max. Height FFL1500.
 Min. Height FFL900.

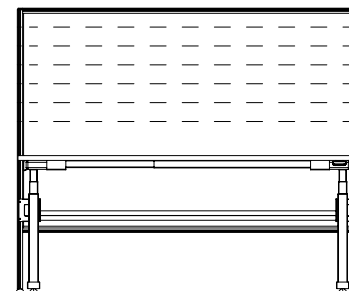
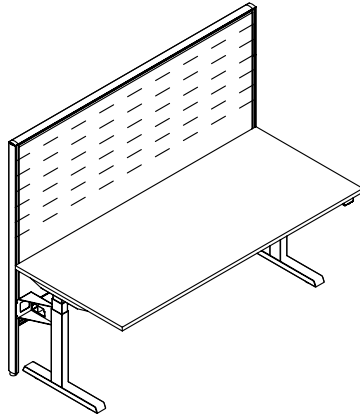

MAX. FFL 1500

MIN. FFL 900

FFL 0000

SCREEN WITH H-FRAME LEG

Max. Height FFL1500.
 Min. Height FFL900.

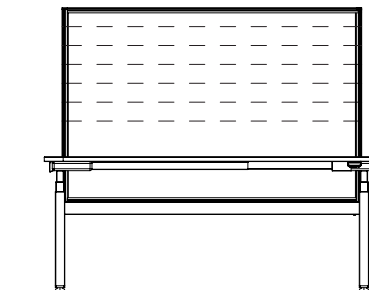
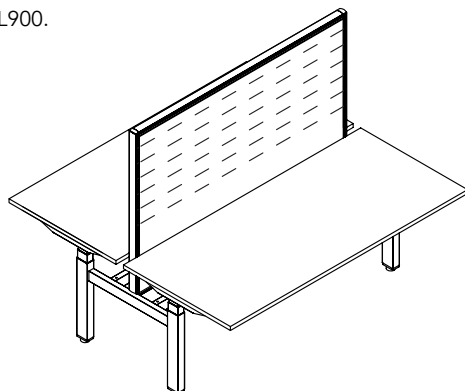

MAX. FFL 1500

MIN. FFL 900

FFL 0000



Watts Commercial Furniture

350a Edgar St
 Bankstown NSW 2200
 PO Box 275 Condell Park 2200
 ABN: 54 064 557 893

p: 02 9771 3966
wcf.com.au
sales.watts@wcf.com.au
accounts.watts@wcf.com.au

Watts Commercial Furniture reserves the right to change any or all details without prior notice. Every effort has been made to ensure the information is accurate at the time of printing.

August 2023

Altura Workstation - Options.

Please refer to a physical sample.
 Images are for an indicative reference only.
 Actual product may vary slightly, depending upon model configurations.

PANEL HUNG SHELF (HORIZONTAL ADJUSTMENT)

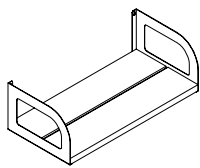

Panel Hung Shelf D-END
(Aluminium)

Standard Size
 600W x 290D x 190H
 900W x 290D x 190H

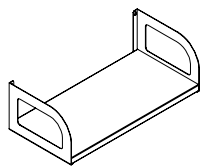

Panel Hung Shelf D-END
(Melamine)

Standard Size
 600W x 290D x 190H
 900W x 290D x 190H

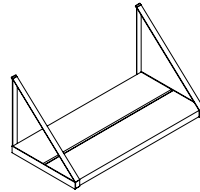

Panel Hung Shelf Wire-END
(Aluminium)

Standard Size
 600W x 300D x 300H
 900W x 300D x 300H

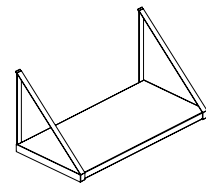

Panel Hung Shelf Wire-END
(Melamine)

Standard Size
 600W x 300D x 300H
 900W x 300D x 300H

PANEL HUNG SHELF (VERTICAL ADJUSTMENT)

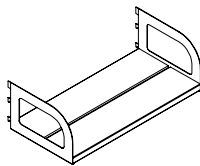

Panel Hung Shelf D-END
(Aluminium)

Standard Size
 600W x 290D x 190H
 900W x 290D x 190H

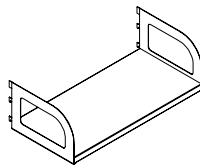

Panel Hung Shelf D-END
(Melamine)

Standard Size
 600W x 290D x 190H
 900W x 290D x 190H

SHELF DIVIDER



Shelf Divider
(Aluminium)

Standard Size
 270D x 175H

WALL HUNG SHELF

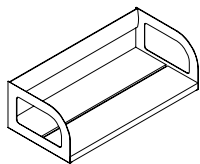

Panel Hung Shelf D-END
(Aluminium)

Standard Size
 600W x 290D x 190H
 900W x 290D x 190H

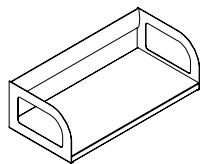

Panel Hung Shelf D-END
(Melamine)

Standard Size
 600W x 290D x 190H
 900W x 290D x 190H

CLAMP-ON ACCESSORIES

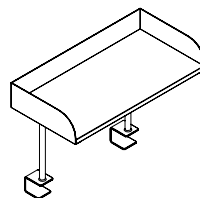

Clamp on Shelf

Standard Size
 600W x 300D x 100H
 325mm above benchtop

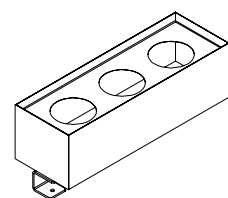

Clamp on Planter Box

Standard Size
 600W x 200D x 175H
 75mm above benchtop

Watts Commercial Furniture

350a Edgar St
 Bankstown NSW 2200
 PO Box 275 Condell Park 2200
 ABN: 54 064 557 893

p: 02 9771 3966
 wcf.com.au
 sales.watts@wcf.com.au
 accounts.watts@wcf.com.au

Watts Commercial Furniture reserves the right to change any or all details without prior notice. Every effort has been made to ensure the information is accurate at the time of printing.

August 2023

Altura Workstation - Options.

Please refer to a physical sample.
 Images are for an indicative reference only.
 Actual product may vary slightly, depending upon model configurations.

MOBILE STORAGE UNITS (MELAMINE)

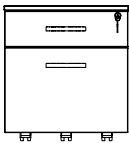

MD5
470W x 570D x 510H

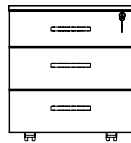

MD6
470W x 570D x 510H

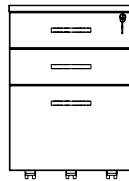

MD7
470W x 570D x 650H

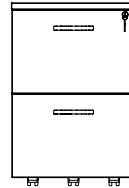

MD8
470W x 570D x 690H

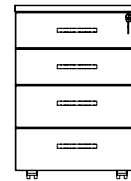

MD9
470W x 570D x 650H

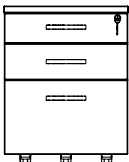

MD10
470W x 570D x 600H

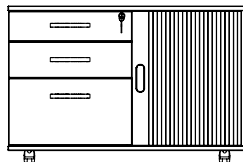

MCT3
900W x 570D x 600H

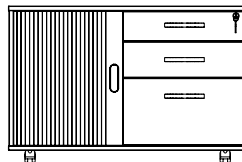

MCT4
900W x 570D x 600H

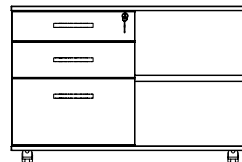

MC1
900W x 570D x 600H

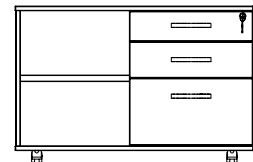

MC2
900W x 570D x 600H

MOBILE STORAGE UNITS (METAL)



MM1
390W x 520D x 600H

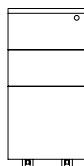

MN1
300W x 520D x 600H

Altura Workstation - Options.

Please refer to a physical sample.
Images are for an indicative reference only.
Actual product may vary slightly, depending upon model configurations.

ABOVE DESK POWER / DATA

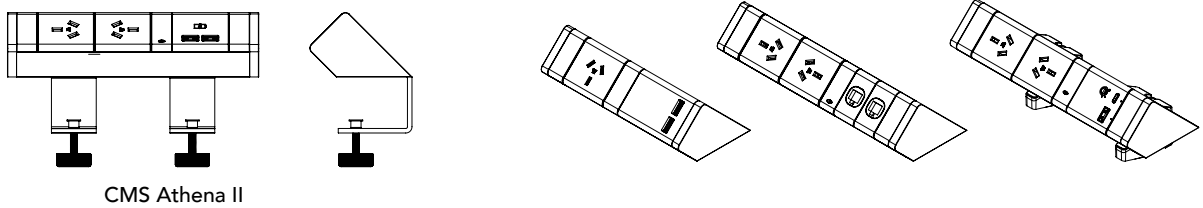

CMS Athena II

IN-DESK POWER / DATA

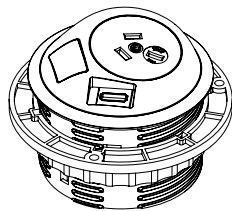

elsafe Pixel

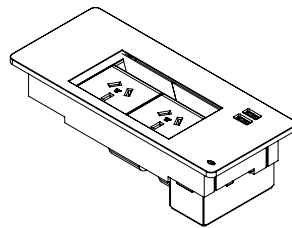

CMS Flip

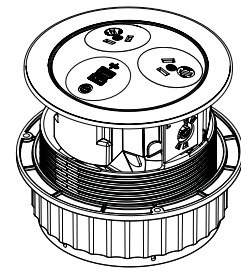

elsafe Pandora

IN-DESK SINGLE LID POWER BOX

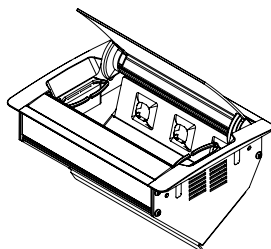

CMS Accede

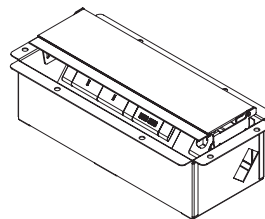

CMS Executive

WIRELESS CHARGING



CMS Quantum



CMS Vibe

Watts Commercial Furniture

350a Edgar St
Bankstown NSW 2200
PO Box 275 Condell Park 2200
ABN: 54 064 557 893

p: 02 9771 3966
wcf.com.au
sales.watts@wcf.com.au
accounts.watts@wcf.com.au

Watts Commercial Furniture reserves the right to change any or all details without prior notice. Every effort has been made to ensure the information is accurate at the time of printing.

August 2023

Altura Workstation - Options.

Please refer to a physical sample.
 Images are for an indicative reference only.
 Actual product may vary slightly, depending upon model configurations.

CABLE BASKETS

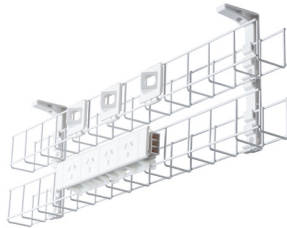

SPECIFICATIONS

| | |
|--------------------------|---|
| Single tier, 100mm wide: | 650 / 950 / 1250 / 1550 / 1750 / 2050mm |
| Dual tier, 100mm wide: | 650 / 950 / 1250 / 1550 / 1750 / 2050mm |

UMBILICAL (CMS CIRQLATE)



SPECIFICATIONS

| | |
|--|--|
| Cirqlate size: | 72 x 15mm |
| Standard length: | 770 / 2100 / 2800mm |
| Standard colour options: | Black, Silver, Clear, White |
| Special colour options: (Min. quantities apply) | Aqua, Light Green, Dark Green, Dark Blue, Light Blue, Orange, Pink, Yellow and Dark Red |

MONITOR ARMS (FLO)

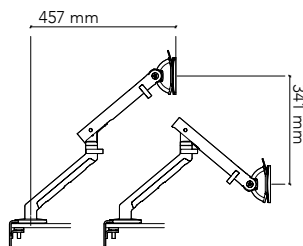

SPECIFICATIONS

| | |
|-----------------------|---|
| Monitor weight range: | Max. 9kg per arm |
| Tilt range: | 48.5° upwards, 48.5° downwards |
| Horizontal range: | 570mm for desk clamp versions |
| Vertical range: | 341mm |
| Colour: | silver, white and black |
| Monitor head: | VESA 75 & 100 compliant |
| Fixing options: | Split clamp, Dual split clamp, Through desk kit |

MONITOR ARMS (C.ME)

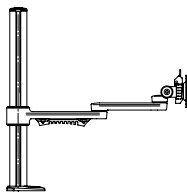

SPECIFICATIONS

| | |
|-----------------------|--------------------------------|
| Monitor weight range: | Max. 8kg per arm |
| Post height: | 430mm (Standard), 740mm (Long) |
| Adjustment range: | 330mm |
| Adjustment range: | 695mm |
| Horizontal range: | 445mm |
| Colour: | white, polished and black |
| Monitor head: | VESA compliant |

Watts Commercial Furniture

350a Edgar St
 Bankstown NSW 2200
 PO Box 275 Condell Park 2200
 ABN: 54 064 557 893

p: 02 9771 3966
 wcf.com.au
 sales.watts@wcf.com.au
 accounts.watts@wcf.com.au

Watts Commercial Furniture reserves the right to change any or all details without prior notice. Every effort has been made to ensure the information is accurate at the time of printing.

August 2023

Altura Workstation - Options.

Please refer to a physical sample.
Images are for an indicative reference only.
Actual product may vary slightly, depending upon model configurations.

CPU HOLDER (CPU60)

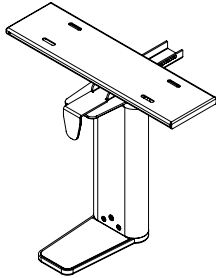

SPECIFICATIONS

| | |
|-----------------------|-----------------------|
| Max. weight capacity: | 10kg |
| Min. CPU size: | 270mm x 75mm |
| Max. CPU size: | 370mm x 200mm |
| Colour options: | White, Silver & White |

CPU HOLDER (LOOP)



SPECIFICATIONS

| | |
|-----------------------|---------------|
| Max. weight capacity: | 20kg |
| Min. CPU size: | 275mm x 90mm |
| Max. CPU size: | 550mm x 225mm |
| Colour options: | Black |

KEYBOARD LOZENGE (METAL)

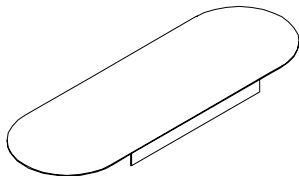

SPECIFICATIONS

| | |
|-------------------------|-------------------|
| Overall size: | 600W x 200D (mm) |
| Min. worktop thickness: | 25mm |
| Max. worktop thickness: | 33mm |
| Colour options: | Powder Coat Range |

Watts Commercial Furniture

350a Edgar St
Bankstown NSW 2200
PO Box 275 Condell Park 2200
ABN: 54 064 557 893

p: 02 9771 3966
wcf.com.au
sales.watts@wcf.com.au
accounts.watts@wcf.com.au

Watts Commercial Furniture reserves the right to change any or all details without prior notice. Every effort has been made to ensure the information is accurate at the time of printing.

August 2023

Finishes - Boards - Laminex Commercial Range.

Please refer to a physical sample.
Colours are for an indicative reference only.
Actual colour and finish may vary slightly.

| | | | | |
|--|---|---|--|---|
|  |  |  |  |  |
| Polar White (F) G1 | White (F, NU) G1 | Parchment (F) G1 | Moleskin (F) G2 | Ghostgum (F) G2 |
|  |  |  |  |  |
| Aries (F) G2 | Oyster Grey (F) G1 | Spinifex (F) G2 | Fox (F) G1P | Tornado (F) G1P |
|  |  |  |  |  |
| Lava Grey (N) G2 | Fossil (F) G1P | Olivine (F) G2 | Otway (F) G2 | French Navy (F) G2 |
|  |  |  |  | Legend (N) Natural Finish (F) Flint Finish (C) Chalk Finish (NU) Nuance Finish |
| Charcoal (F) G1 | Battalion (F) G1P | Terril (F) G2 | Black (F, NU) G1P | |

Finishes - Boards - Laminex Commercial Range.

Please refer to a physical sample.
Colours are for an indicative reference only.
Actual colour and finish may vary slightly.



Alaskan (N)
G1P

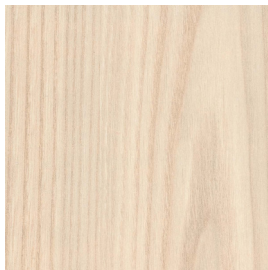

Milkwood (N)
G1P

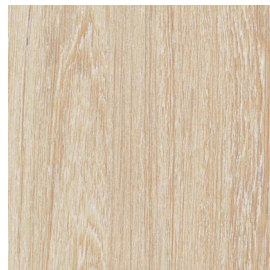

Seasoned Oak (N, C)
G1

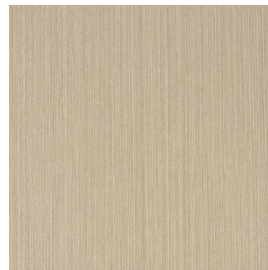

Oyster Linea (N, NU)
G1



Dansk Maple (F)
G1

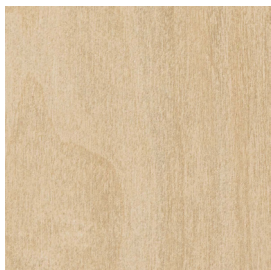

Raw Birchply (N, C)
G1P

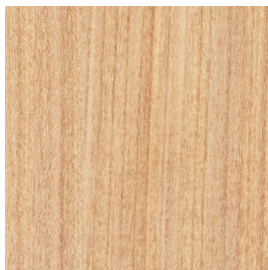

Silver Ash (F)
G2

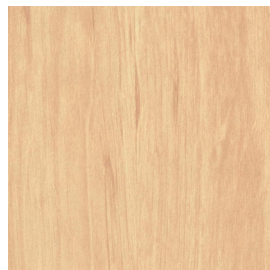

Young Beech (F)
G1P



Rock Maple (N)
G2



Curly Birch (F)
G1P

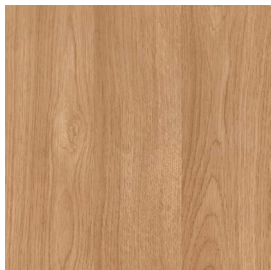

Elegant Oak (N, C)
G1P

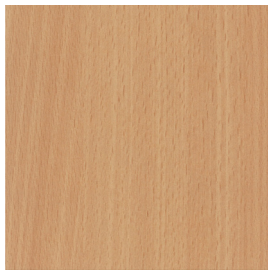

Select Beech (F)
G1P

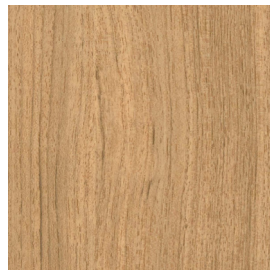

Sublime Teak (N, C)
G1P



Classic Oak (N, NU)
G1



Rural Oak (N, C)
G1P

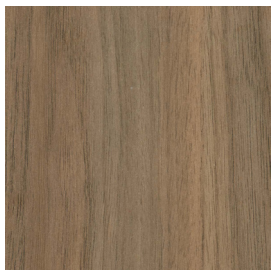

Natural Walnut (N, C)
G1P



Lustrous Elm (N, NU)
G1P

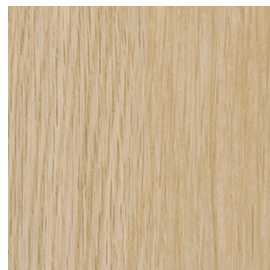

Calm Oak (N, C)
G2

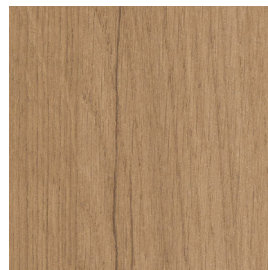

Planked Urban Oak (N, C)
G2

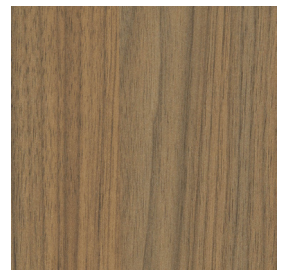

Danish Walnut (N, C)
G2

Watts Commercial Furniture

350a Edgar St
Bankstown NSW 2200
PO Box 275 Condell Park 2200
ABN: 54 064 557 893

p: 02 9771 3966
wcf.com.au
sales.watts@wcf.com.au
accounts.watts@wcf.com.au

Watts Commercial Furniture reserves the right to change any or all details without prior notice. Every effort has been made to ensure the information is accurate at the time of printing.

August 2023

Finishes - Boards - Laminex Commercial Range.

Please refer to a physical sample.
Colours are for an indicative reference only.
Actual colour and finish may vary slightly.

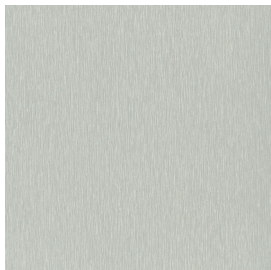

Zincworks (N)
G1P



Fox Teakwood (N, C)
G1P



New Graphite (F)
G1P



Burnished Wood (N, NU)
G2

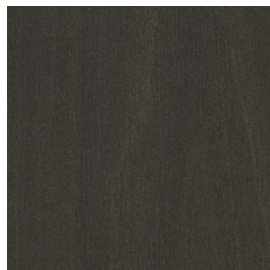

Black Birchply (N, C)
G2

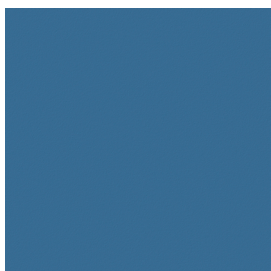

Portsea (F)
G2

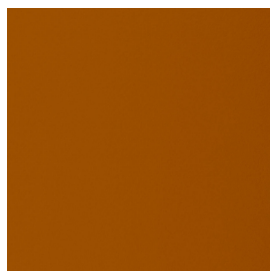

Moroccan Clay (F)
G2



Golden Wattle (F)
G2



Coastal Sunrise (F)
G2



Pillarbox (F)
G2

Legend

- (N) Natural Finish
- (F) Flint Finish
- (C) Chalk Finish
- (NU) Nuance Finish

Watts Commercial Furniture

350a Edgar St
Bankstown NSW 2200
PO Box 275 Condell Park 2200
ABN: 54 064 557 893

p: 02 9771 3966
wcf.com.au
sales.watts@wcf.com.au
accounts.watts@wcf.com.au

Watts Commercial Furniture reserves the right to change any or all details without prior notice. Every effort has been made to ensure the information is accurate at the time of printing.

August 2023

Finishes - Boards - Polytec Ravine Range.

Please refer to a physical sample.
Colours are for an indicative reference only.
Actual colour and finish may vary slightly.



Notaio Walnut



Satra Wood



Natural Oak



Bleached Walnut



Soft Walnut



Drifted Oak



Distressed Wood

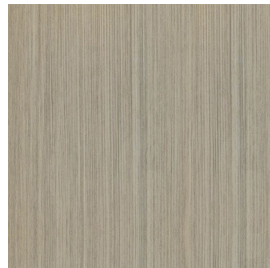

Tessuto Milan



Maison Oak

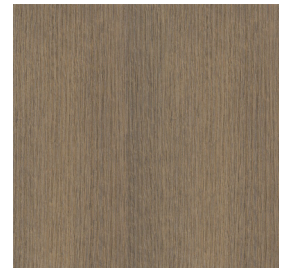

Sepia Oak

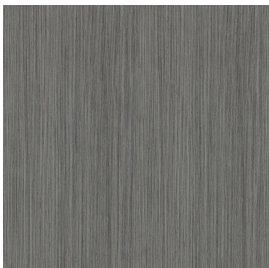

Maroso Milan



Char Oak



Cafe Oak

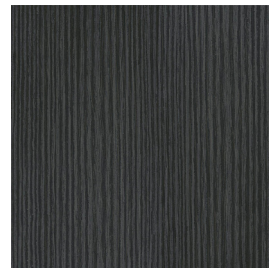

Black Wenge

Watts Commercial Furniture

350a Edgar St
Bankstown NSW 2200
PO Box 275 Condell Park 2200
ABN: 54 064 557 893

p: 02 9771 3966
wcf.com.au
sales.watts@wcf.com.au
accounts.watts@wcf.com.au

Watts Commercial Furniture reserves the right to change any or all details without prior notice. Every effort has been made to ensure the information is accurate at the time of printing.

August 2023

Finishes - Boards - Veneer Range.

Please refer to a physical sample.
Colours are for an indicative reference only.
Actual colour and finish may vary slightly.



Figured Sycamore
(Quarter-cut)



Rock Maple
(Crown-cut)

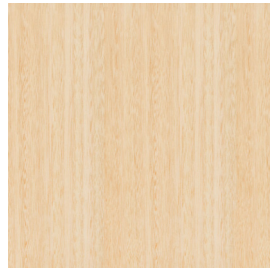

Victorian Ash
(Quarter-cut)



American Cherry
(Crown-cut)



European Beech
(Crown-cut)

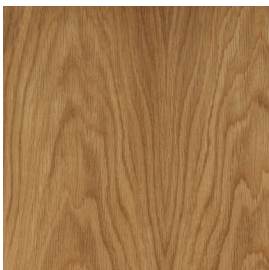

American White Oak
(Crown-cut)

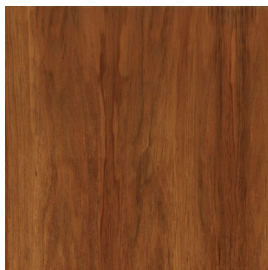

Tasmanian Blackwood
(Crown-cut)



Tasmanian Oak
(Quarter-cut)

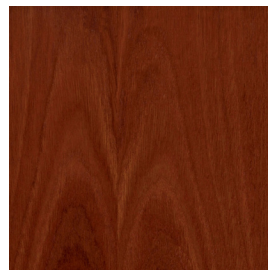

Jarrah (Crown-cut)

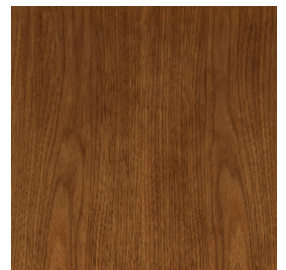

American Walnut
(Crown-cut)

Edge Profiles

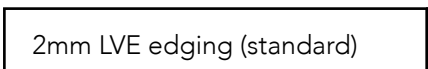

2mm LVE edging (standard)



Waterfall solid timber edging



Bull nose solid timber edging

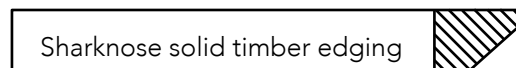

Sharknose solid timber edging

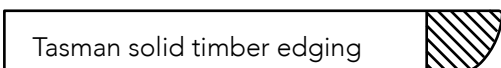

Tasman solid timber edging

Other edge profiles also available.
Please contact us for further information.

Watts Commercial Furniture

350a Edgar St
Bankstown NSW 2200
PO Box 275 Condell Park 2200
ABN: 54 064 557 893

p: 02 9771 3966
wcf.com.au
sales.watts@wcf.com.au
accounts.watts@wcf.com.au

Watts Commercial Furniture reserves the right to change any or all details without prior notice. Every effort has been made to ensure the information is accurate at the time of printing.

August 2023

Finishes - Screen Fabric.

Please refer to a physical sample.
Colours are for an indicative reference only.
Actual colour and finish may vary slightly.

Suzette



Limone



Splice



Pistachio



Mint

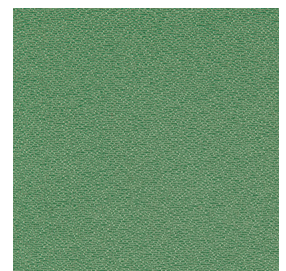

Celery

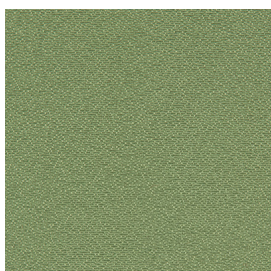

Decor



Citrus



Opal



Lucerne

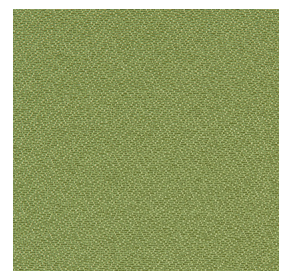

Hula



Humbug

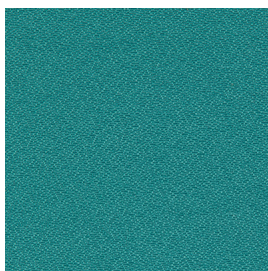

Joker

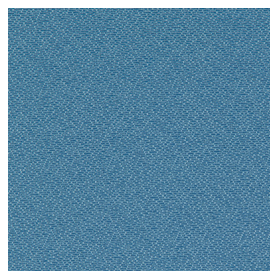

Mainsail

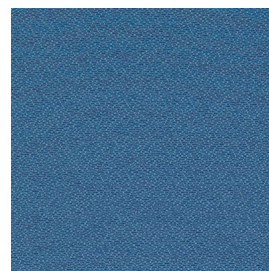

Luxury

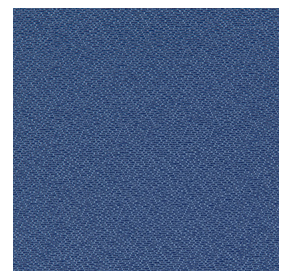

Olympia

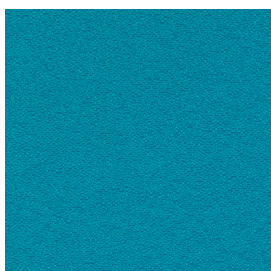

Cyan



Tiffany

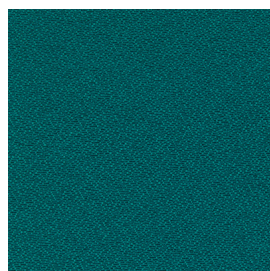

Aero



Iris



Dolphin

Watts Commercial Furniture

350a Edgar St
Bankstown NSW 2200
PO Box 275 Condell Park 2200
ABN: 54 064 557 893

p: 02 9771 3966
wcf.com.au
sales.watts@wcf.com.au
accounts.watts@wcf.com.au

Watts Commercial Furniture reserves the right to change any or all details without prior notice. Every effort has been made to ensure the information is accurate at the time of printing.

August 2023

Finishes - Screen Fabric.

Please refer to a physical sample.
Colours are for an indicative reference only.
Actual colour and finish may vary slightly.

Suzette



Twist

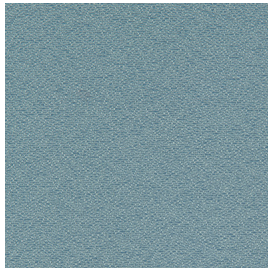

Heaven

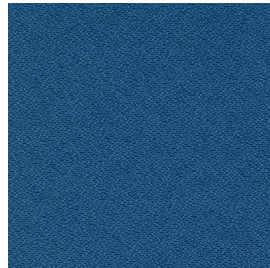

Conquest

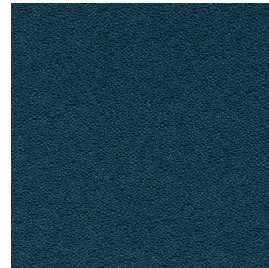

Octane

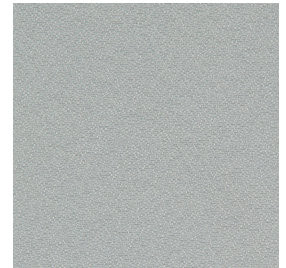

Blizzard



Tequila

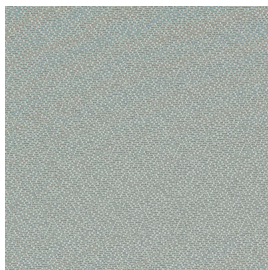

Pavement

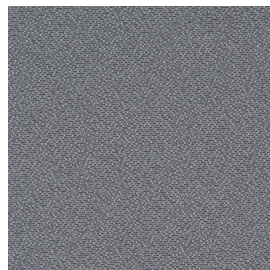

Spire



Periwinkle



Nimble



Shadow

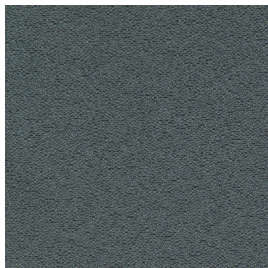

Sinker



Stormcloud

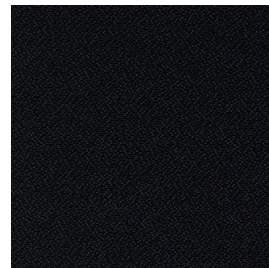

Stallion

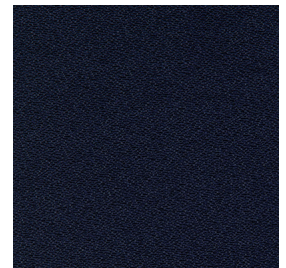

Popeye



Mulberry

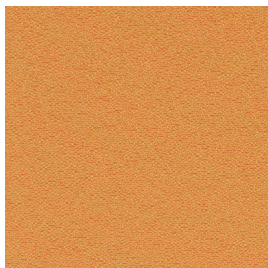

Pizzazz

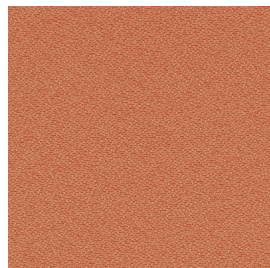

Vibrant



Russet

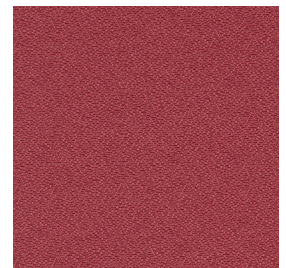

Gala

Watts Commercial Furniture

350a Edgar St
Bankstown NSW 2200
PO Box 275 Condell Park 2200
ABN: 54 064 557 893

p: 02 9771 3966
wcf.com.au
sales.watts@wcf.com.au
accounts.watts@wcf.com.au

Watts Commercial Furniture reserves the right to change any or all details without prior notice. Every effort has been made to ensure the information is accurate at the time of printing.

August 2023

Finishes - Screen Fabric.

Please refer to a physical sample.
Colours are for an indicative reference only.
Actual colour and finish may vary slightly.

Suzette

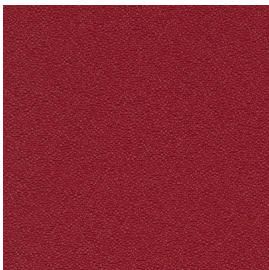

Rosso



Organic

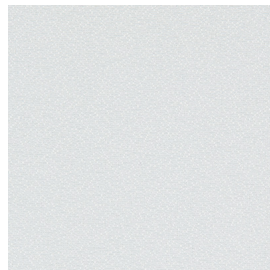

White



Eggshell



Ivory

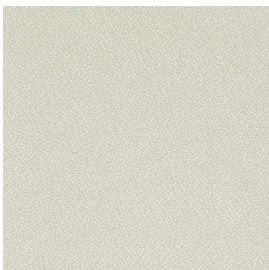

Ice cream



Neutral



Cafe

Watts Commercial Furniture

350a Edgar St
Bankstown NSW 2200
PO Box 275 Condell Park 2200
ABN: 54 064 557 893

P • 28 | wcf.com.au

p: 02 9771 3966
wcf.com.au
sales.watts@wcf.com.au
accounts.watts@wcf.com.au

Watts Commercial Furniture reserves the right to change any or all details without prior notice. Every effort has been made to ensure the information is accurate at the time of printing.

August 2023

Finishes - PET - Autex Cube.

Please refer to a physical sample.
Colours are for an indicative reference only.
Actual colour and finish may vary slightly.

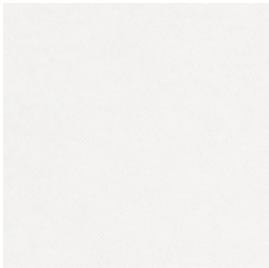

Pavilion

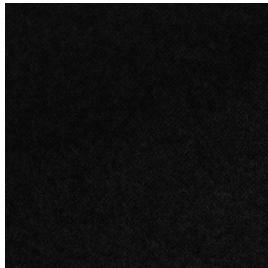

Petronas

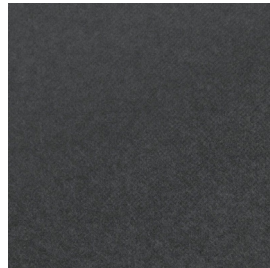

Empire

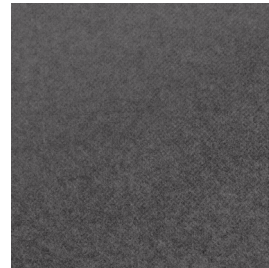

Herald



Flatiron



Parthenon



Savoye



Opera



Falling Water

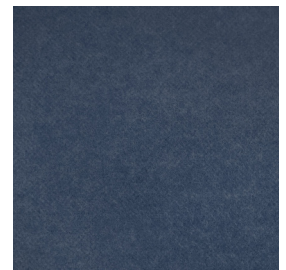

Muralla

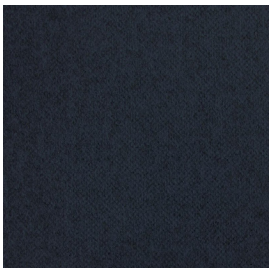

Pinnacle

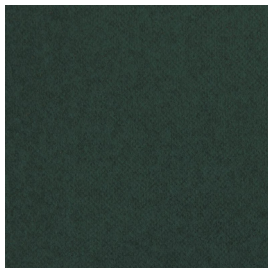

Tree House



Gherkin

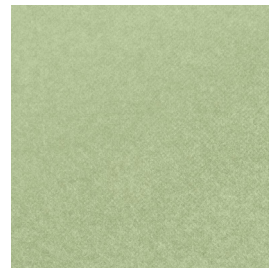

Acros

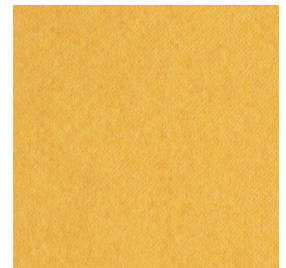

Senado



Beehive

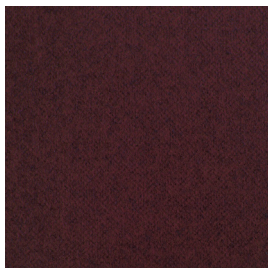

Sargazo

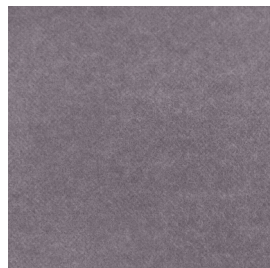

Cavalier



Rosada

Watts Commercial Furniture

350a Edgar St
Bankstown NSW 2200
PO Box 275 Condell Park 2200
ABN: 54 064 557 893

p: 02 9771 3966
wcf.com.au
sales.watts@wcf.com.au
accounts.watts@wcf.com.au

Watts Commercial Furniture reserves the right to change any or all details without prior notice. Every effort has been made to ensure the information is accurate at the time of printing.

August 2023

WATTS COMMERCIAL FURNITURE AND THE ENVIRONMENT

Watts Commercial Furniture (WCF) manufactures a wide range of high quality commercial furniture for Government departments (Commonwealth, State and Local) and corporate organisations. WCF is a one stop shop where we design, manufacture and install all of our systems and products.

We conduct our business with due concern and protection of the natural environment which includes biodiversity and ecosystems. Our Environmental Policy is a statement of commitment from Management and reflects the values and ethos of the company.

It is our intention to maintain a sustainable, environmentally responsible business which respects the quality of the environment and uses resources efficiently.

To that end, we are committed to:

- Complying with environmental laws and regulation.
- Complying with AFRDI Green Tick Certification.
- Understanding market expectations and industry trends.
- Consideration of environmental issues in business strategies and initiatives
- Reducing pollution.
- Recycling and material minimization whenever possible.
- Implementing energy efficient practices.
- Setting environmental objectives.
- Creating an awareness of environmental issues through ongoing education and training.
- Promoting sustainability awareness within our supply chain.
- Taking a life cycle approach for product design, manufacturer and end of life.
- Striving for continual improvement to enhance environmental performance.

Our company's commitment extends to operating in accordance with the International standard's ISO 14001: 2015 (EMS).

PAT LETO

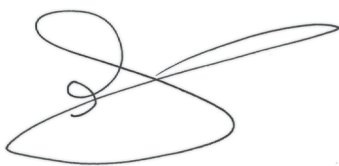

Chief Executive Officer 01 April 2019



QUALITY COMMITMENT

Watts Commercial Furniture (WCF) manufactures and supplies a wide range of high quality commercial furniture to Government Departments and Corporate Organisations. WCF is a one stop shop where we design, manufacture and install all of our systems and products.

All members of the organisation are actively involved in the process of continuous improvement, which is monitored against measureable objectives. We do this by ensuring the implementation and ongoing improvement of an Integrated Management System of processes and procedures to reduce risk, exploit opportunities, in the company's commitment to meeting its customer needs and expectations.

Our quality objectives include striving for continual improvement in our systems, products and services through on-going staff training and development; seeking and responding to customer feedback; and through providing a world's best practice safe working environment.

We also constantly seek advancement by ensuring the implementation and ongoing improvement of a Management System of processes and procedures that serve to reduce risk and exploit opportunities. Through our Quality Management System conforming to ISO 9001:2015, we constantly seek to improve the quality of our products and services, in line with evolving management considerations and requirements.

We also seek to preserve our well-earned reputation for providing high levels of service to our customers, coupled with optimum quality products, at competitive prices and market leading minimal lead times. WCF also provides our customers with value added support and backup that they can depend on.

PAT LETO

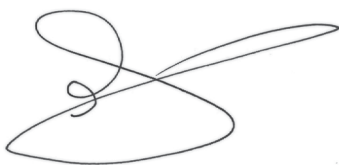

Chief Executive Officer 01 April 2019





Watts Commercial Furniture
350a Edgar St
Bankstown NSW 2200

p: 02 9771 3966

sales.watts@wcf.com.au
accounts.watts@wcf.com.au

www.wcf.com.au

Watts Commercial Furniture reserves the right to change any or all details without prior notice. every effort has been made to ensure the information is accurate at the time of printing.

August 2023